

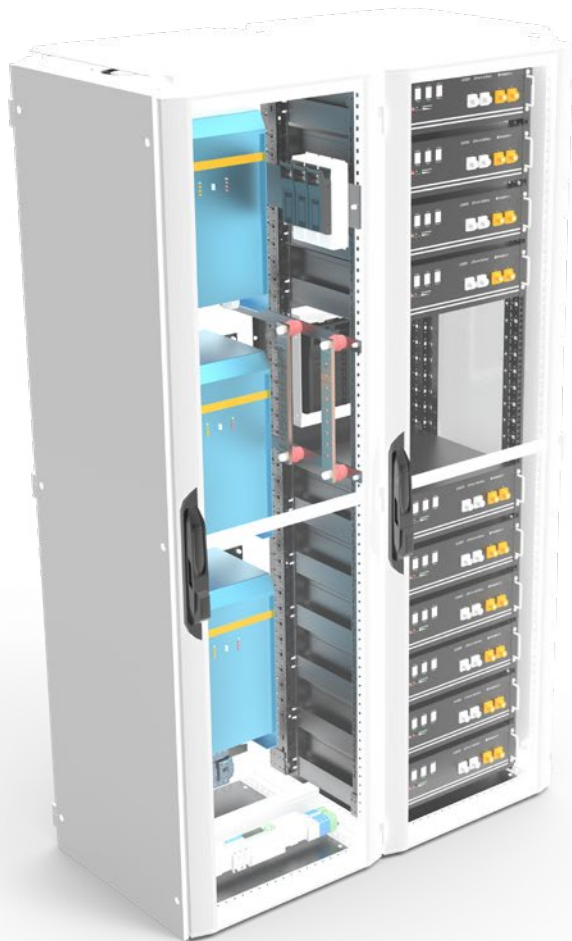

RMB ENERGIE

A **YANMAR** COMPANY



MANUAL

neoTower® Power storage
Valid as of 02/2022

Table of Contents

Table of Contents

1.	Document information	3
1.1	Validity	3
1.2	Supplementary information	3
1.3	Safety information	4
1.4	Explanation of symbols	4
2.	Safety information	5
2.1	Intended use	5
2.2	Authorised target groups	5
2.2.1	Manufacturer	5
2.2.2	Operator	5
2.2.3	Technician	5
2.2.4	User	5
2.3	General safety instructions	6
2.4	Safety information	7
2.5	Protective devices	7
2.6	Handling the battery modules	7
3.	Product information	8
3.1	Principle of operation	8
3.2	Registration with the energy supplier	8
3.3	Product versions	8
3.4	Scope of delivery	9
3.5	Dimensions	9
4.	Installation and commissioning	10
4.1	Installation site requirements	10
4.2	Placement	10
4.3	Connection	10
5.	Display and operation	14
5.1	Inverter LED display	14
5.2	Charger LED display	15
5.3	Battery module operation	17
5.4	Explanation of terms	18
6.	Maintenance	20
6.1	Functional checks	20
6.2	Cleaning	20
7.	Disassembly and disposal	21
7.1	Disassembly	21
7.2	Disposal	21
8.	Technical data	22
8.1	Technical data sheet BSS	22
8.2	Technical data sheet BOS	23

1. Document information



1.1 Validity

Translation of the original operating manual. In this manual the product is referred to as "system or "unit".

This manual is valid for the following products:

Battery storage system (BSS)

- BSS 7
- BSS 11
- BSS 21

Blackout start (BOS)

- BOS 18
- BOS 21
- BOS 36
- BOS 57
- BOS 114

This manual is protected by copyright. Reproduction, reprinting and distribution is only permitted with the consent of the manufacturer.

Subject to change without notice.

1.2 Supplementary information

The following supplementary information and documents are available at www.rmbenergie.com:

-  Technical data
-  Product brochure
-  Registration documents for the energy supplier

Document information

1.3 Safety information

DANGER!

Information highlighted with the word DANGER indicates a hazardous situation that will result in death or serious injury.

WARNING!

Information highlighted with the word WARNING indicates a hazardous situation that can result in death or serious injury.

CAUTION!

Information highlighted with the word CAUTION indicates a situation that can cause slight or moderate injury.

ATTENTION!

Information highlighted with the word ATTENTION indicates a situation that can cause damage to property or the environment.

1.4 Explanation of symbols

Texts

- ▶ Required action
- List
- D Reference to other places in this document
-  Reference to other documents that must be observed
- Web link

Illustrations

In this manual the neoTower® BOS 21 power storage is shown as an example. Illustrations may differ from other models. If you have any questions, please contact the manufacturer.

2. Safety information



2.1 Intended use

The unit is a battery power storage system which can boost coverage of the building's power consumption. With this system the surplus generated electricity is stored in high-quality, modern batteries.

The system may only be used if it is in perfect technical condition and has been commissioned by the manufacturer or by a specialist partner authorised by the manufacturer.

Intended use also includes reading and complying with the instructions in this manual.

Any other use is considered to be contrary to the intended use.

2.2 Authorised target groups

This manual is intended for different target groups that are authorised for specific assignments.

2.2.1 Manufacturer

The manufacturer supplies the product and has the following responsibilities:

- Training of technicians for assembly, maintenance, disassembly and disposal.
- Commissioning of the system.

Only the manufacturer has access to the "Expert" area in the "RMB/Control".

2.2.2 Operator

The operator is responsible for the building in which the product is used. The operator has the following responsibilities:

- Compliance with requirements by the energy supplier (e.g. registration, licensing, remuneration).
- Compliance with the installation site requirements.
- Induction of users.
- Compliance with legal occupational safety regulations.
- Compliance with applicable safety, accident prevention and environmental protection regulations.
- Provision and observance of documentation.
- Ensuring that the product is always in a technically perfect condition.
- If necessary, storage of the system.

2.2.3 Technician

Technicians are responsible for the assembly, maintenance, disassembly and disposal of the product. The following points must be observed:

- Work may only be carried out by qualified personnel who have been trained by the manufacturer and are familiar with installation engineering, gas and water installations as well as the applicable safety regulations.
- Special work during installation (e.g. work involving the building's structure or the ventilation system) may only be carried out by appropriately qualified personnel from specialist companies.
- Electrical installations may only be carried out by qualified electricians.

Only skilled personnel who have been trained by the manufacturer have access to the "Technician" area in the "RMB/Control".

2.2.4 User

Users are permitted to carry out certain operational and cleaning tasks. User requirements:

- Users must be trained by the operator on the product.
- They must be familiar with the instructions in this manual.

Authorised users have access to the unprotected areas in the "RMB/Control", but not to the "Expert" and "Technician" areas.

2.3 General safety instructions

WARNING!

Danger resulting from non-compliance with these instructions!

This manual contains important information for safe handling of the system. Special attention is drawn to possible hazards. Failure to comply with warnings may result in death or serious injury.

- ▶ Read the instructions carefully.
- ▶ Follow the safety instructions in this manual.
- ▶ Observe the safety instructions on the system.
- ▶ Keep the instructions in an easily accessible place.

Use of the system is prohibited:

- If the system or individual components are damaged.
- If unauthorised alterations or modifications have been made to the system.
- If protective devices are non-functional or missing.
- During the construction phase of the building.
- After storage of the system for more than 6 months after delivery.
- After decommissioning of the system for more than 6 months.
- By children or persons who cannot assess hazards when handling the system.

In the following cases the manufacturer does not assume any liability or warranty in the event of damage:

- If the instructions in this manual are not followed.
- In the event of improper use.
- In the event of improper handling.
- When used by unauthorised target groups.
- Failure to meet the installation site requirements.
- When using spare parts that are not approved by the manufacturer.
- When bypassing the safety devices on the system.
- If seals and sealings on the system are removed.
- In the event of non-compliance with the maintenance intervals.

2.4 Safety information

DANGER!

Life-threatening electric shock

Bridging the battery terminals causes a short circuit which causes current to flow. Such a short circuit must be avoided at all costs. Observe the following points:

- ▶ Use insulated tools and gloves.
- ▶ Never place any tools or metal parts on the battery modules.
- ▶ Put down metallic objects before starting work.
- ▶ Never operate the system in potentially explosive atmospheres or areas with possible fire hazards.

DANGER!

Fire hazard due to improper handling

Improper handling can cause lithium battery cells to ignite. For this reason always observe the following specifications for handling lithium battery cells:

- ▶ Do not install or operate the battery modules in potentially explosive atmospheres or in areas with high humidity.
- ▶ Store the battery modules in a dry place and within the temperature ranges specified on the data sheet
- ▶ Do not open, puncture or drop the battery modules.
- ▶ Do not expose the battery modules to high temperatures.
- ▶ Do not throw the battery modules into a fire.
- ▶ Do not use defective or damaged battery modules.

DANGER!

Risk of death due to misuse

Any use of the battery storage system other than for its intended purpose or any other use can be extremely dangerous.

WARNING!

Moisture!

- ▶ The system must be installed in a dry place.
- ▶ The system and external cables must be protected against exposure to water.
- ▶ Never clean the system with liquid cleaning agents.

2.5 Protective devices

WARNING!

The protective devices serve to ensure safety when handling the system. Missing or defective protective devices can result in hazardous situations.

- ▶ Make sure that protective devices are not removed.
- ▶ Observe the safety instructions on the individual components of the system.
- ▶

2.6 Handling the battery modules

WARNING!

The battery modules that are compatible with the power storage system are protected by several safety devices and are safe when used as intended. If the batteries are not used as intended or in the event of a fault, the battery cells inside the battery modules can be damaged.

This can have the following consequences:

- Considerable heat generation on the surface of the battery cells.
- Leakage of electrolytes, fumes and/or smoke.
- Ignition of the discharged electrolytes and a flash fire.
- Irritation of the skin, eyes and mucous membranes caused by fumes or smoke from burning battery modules.

To ensure compliance with the intended use of the unit:

- ▶ Do not open the battery modules.
- ▶ Do not mechanically damage (pierce, deform, dismantle etc.) or otherwise modify the battery modules
- ▶ Do not heat the battery modules, keep them away from igniting sources and only operate them within the permitted temperature range.
- ▶ Do not allow the battery modules to come into contact with water (except to extinguish the power storage system in the event of a fire).
- ▶ Do not short-circuit battery modules.
- ▶ Do not continue to use battery modules that have been damaged in any way.
- ▶ Do not permit exhaustive discharge of the battery modules or charge them with external chargers.
- ▶ Do not operate the battery modules outside the storage system.

3. Product information

3.1 Principle of operation

The use of a specially designed power storage increases coverage of the building's power consumption. The excess electricity produced is stored in high-quality batteries.

In addition, a blackout start system can secure the power supply in the event of a blackout of the mains supply network. In the event of a power failure, the system supplies the connected consumers. The system is switched over within milliseconds, ensuring uninterrupted operation of the electronic devices. The systems are of modular design and can be calculated for the required storage capacity.

3.2 Registration with the energy supplier

The energy supplier must be notified when the system is installed. Operator requirements:

- ▶ Inform yourself of any relevant requirements.
- ▶ Notify the energy supplier before installing the system.
- ▶ Meet the energy supplier specifications (e.g. registration, approval).
- ▶ Submit all the relevant system data to the energy supplier.

 Technical data

 The technical data sheets can be downloaded from the manufacturer's website.

3.3 Product versions

Battery storage system (BSS)

- BSS 7
- BSS 11
- BSS 21

Blackout start (BOS)

- BOS 18
- BOS 21
- BOS 36
- BOS 57
- BOS 114

3.4 Scope of delivery

The scope of delivery may vary depending on the system size.



Figure: neoTower® BOS 21 power storage

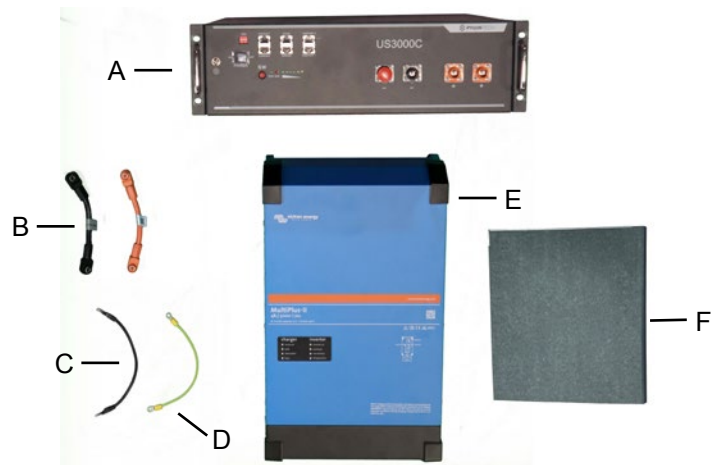

- A Battery
- B Battery connection set (RED/BLACK)
- C Patch cable
- D Grounding cable
- E Inverter
- F Documentation

3.5 Dimensions

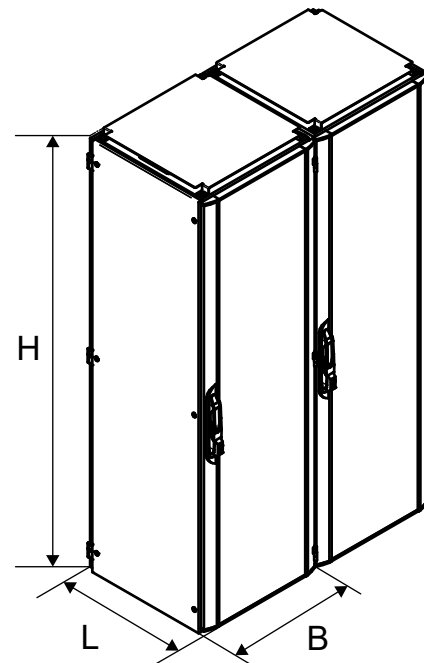

Figure: System cabinet

System cabinet	L (mm)	W (mm)	H (mm)
BSS 7, 11, 21 BOS 18, 21, 36	600	600	2,000
BOS 57, 114	800	800	2,000

Installation and commissioning

4. Installation and commissioning

4.1 Installation site requirements

The system may only be installed in compliance with the following building requirements:

Fire protection:

- ▶ The system must be installed in rooms with suitable fire protection and without fire loads.
- ▶ It is not permitted to install the system in potentially explosive atmospheres.

Floor specifications:

- ▶ The floor must have a firm surface
- ▶ It must be level and clean.

Distances:

The following distances must be maintained to ensure proper ventilation:

- ▶ Distance behind the unit: 10 cm min.
- ▶ Distance at the top of the unit: 10 cm min.
- ▶ Distance at the side of the unit: 10 cm min.
- ▶ Distance below the unit: Determined by the unit supports.

4.2 Placement

The battery storage system can be installed if the requirements listed in 4.1 are met.

- ▶ Remove the packaging material.
- ▶ Check the system for the components listed in the scope of delivery.
- ▶ Remove the Euro pallet and position the system at the intended installation site.

4.3 Connection

The battery storage system can be installed if the requirements listed in 4.1 and 4.2 are met.

- ▶ Connect the system on the mains side (left/yellow frame) and on the building side (right/green frame).
- ▶ Please refer to the enclosed circuit diagram.
- ▶ Circuit diagram.

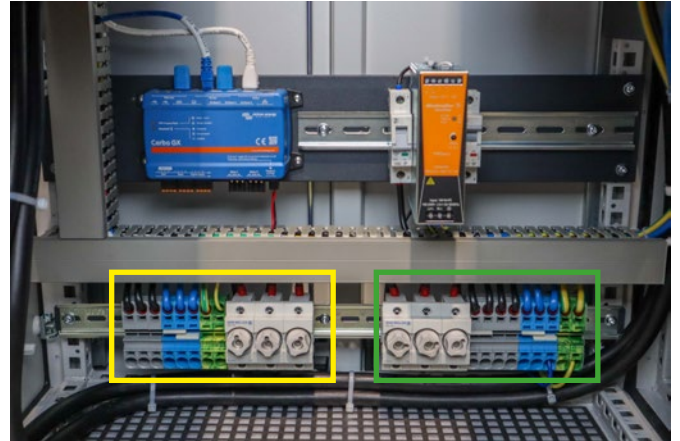

- ▶ Connect the system to the modem of the CHP with the patch cable (1), starting from the battery manager (2). Use a free LAN port to connect to the modem.



Installation and commissioning

► Make the following settings (value table) for the BSS on the screen of the CHP unit:

neoTower®	Min. SoC (unless there is a power failure)			Power specifications, mains network supply		
	BSS 7	BSS 11	BSS 21	BSS 7	BSS 11	BSS 21
2.0	min. 10% / max. 100%			As a rule "0W"		
3.3						
4.0						
5.0						
7.2						

Installation and commissioning

► Make the following settings (value table) for the BOS on the screen of the CHP unit:

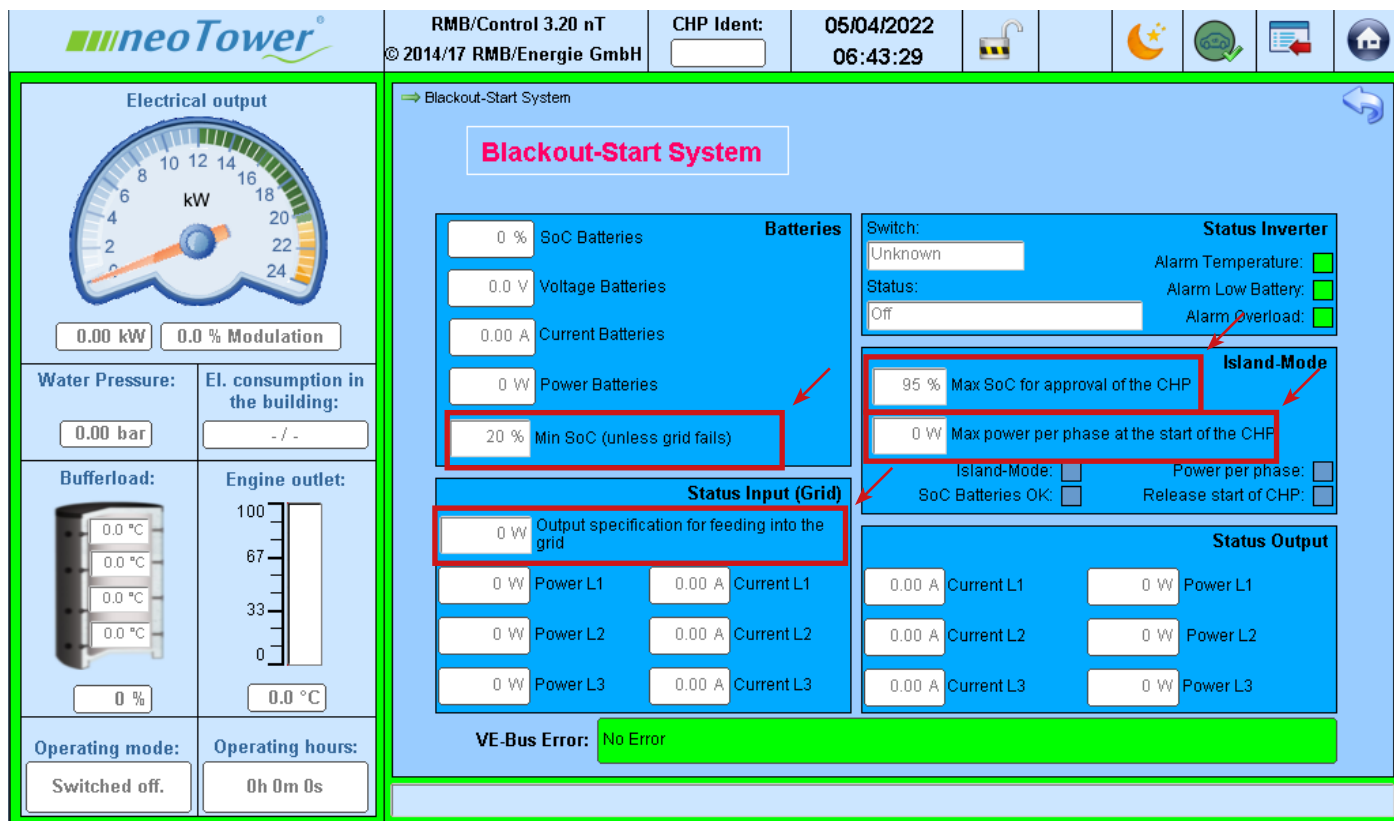

neoTower®	Min. SoC (unless there is a power failure)					Max. SoC for release of the CHP (standalone operation)					
	BOS 18	BOS 21	BOS 36	BOS 57	BOS 114	BOS 18	BOS 21	BOS 36	BOS 57	BOS 114	BOS 114
2.0	min. 10% / max. 100%					min. 20% / max. 80%					
3.3											
4.0											
5.0											
7.2											
9.5											
11.0											
12.5											
16.0											
20.0											
25.0											
30.0											
50.0											

Installation and commissioning

neoTower®	Max. power per phase to start the CHP (standalone operation)					Power specifications, mains network supply				
	BOS 18	BOS 21	BOS 36	BOS 57	BOS 114	BOS 18	BOS 21	BOS 36	BOS 57	BOS 114
2.0	<= 800 W	n/a	n/a	n/a	n/a	As a rule "0W"				
3.3	max. inverter, as starter	max. inverter, as starter	max. inverter, as starter	max. inverter, as starter	max. inverter, as starter					
4.0										
5.0	/	/	n/a	n/a	n/a					
7.2	/	/								
9.5	/	max. inverter, as starter	max. inverter, as starter	max. inverter, as starter	max. inverter, as starter					
11.0	/	/	/	n/a	n/a					
12.5	/	/	max. inverter, as starter	max. inverter, as starter	max. inverter, as starter					
16.0	/	/	/	n/a	n/a					
20.0	/	/	/							
25.0	/	/	/	max. inverter, as starter	max. inverter, as starter					
30.0	/	/	/							
50.0	/	/	/	/						

Display and operation

5. Display and operation

5.1 Inverter LED display

- LED aus
- LED blinkt
- LED brennt

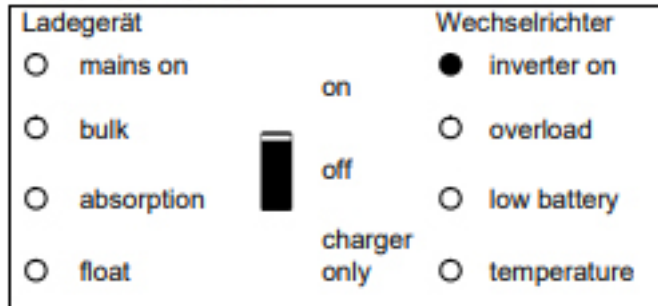

The inverter is in operation and current is flowing to the consumers.

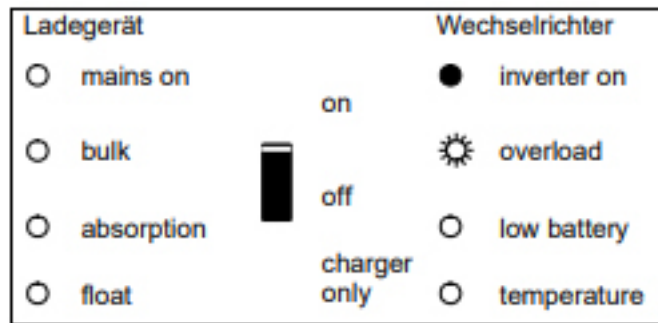

The rated power of the device has been exceeded. The overload indicator is flashing.

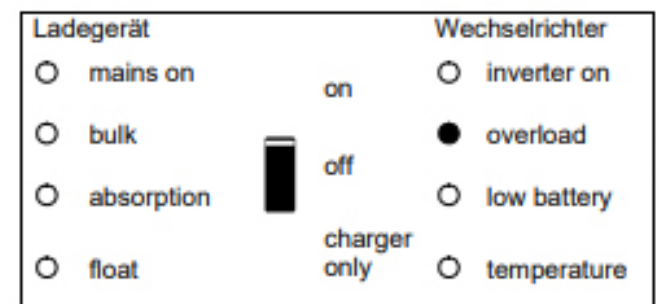

The inverter is switched off due to overload or short circuit.

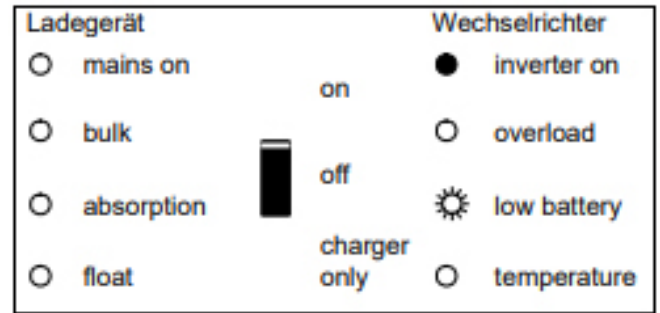

The battery is almost empty.

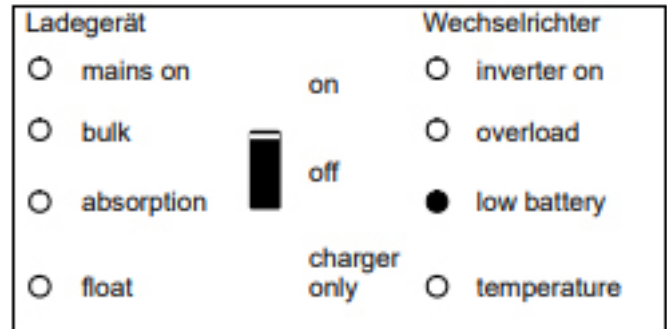

The inverter is switched off as the battery voltage level is too low.

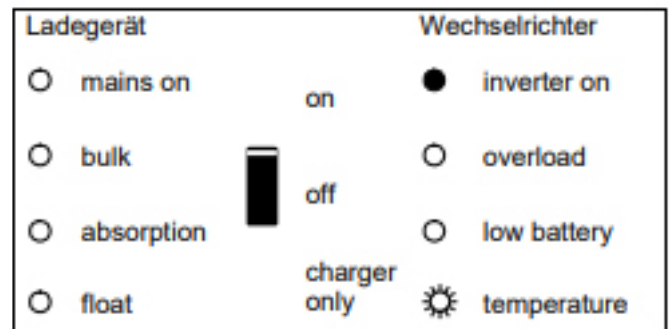

The device temperature has reached a critical value.

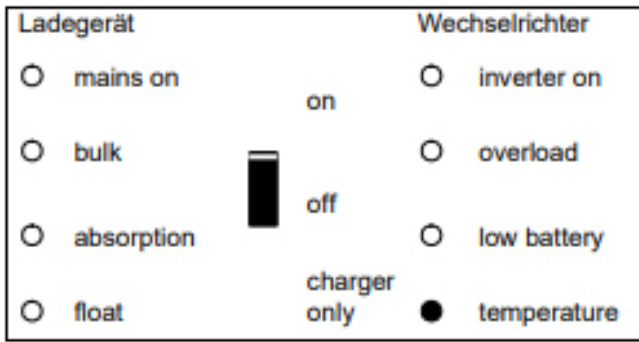

The inverter is switched off as the operating temperature is too high.

5.2 Charger LED display

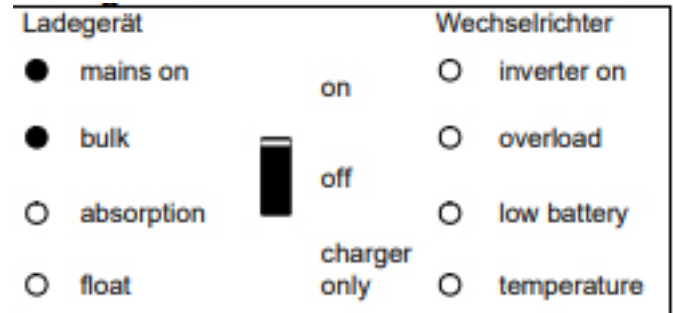

The AC voltage at input AC-in-1 or AC-in-2 is connected through and the charger is in constant current mode ("bulk").

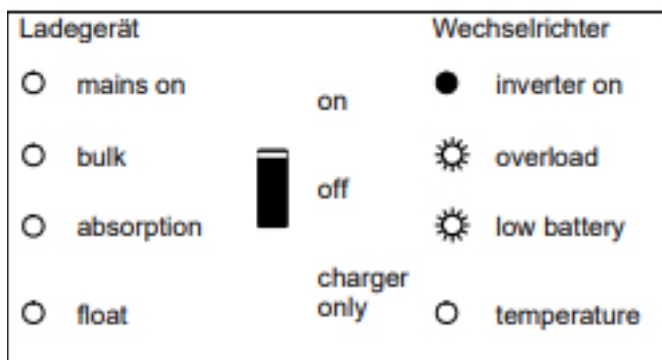

Alternating flashing of the LEDs indicates that the batteries are almost empty and at the same time there is an overload.

If "overload" and "low battery" flash at the same time, the ripple voltage on the battery connection is too high.

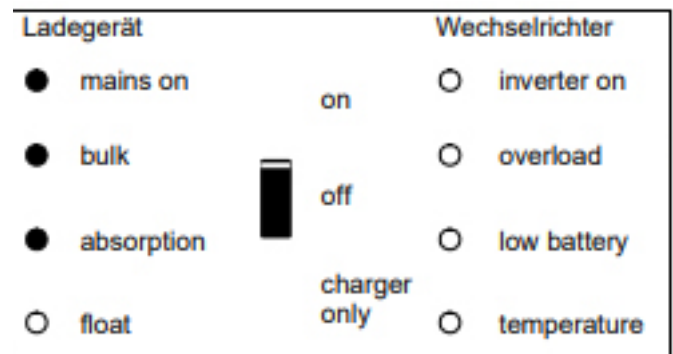

The AC voltage at input AC-in-1 or AC-in-2 is connected through. The device is charging, but the set absorption voltage has not yet been reached (battery protection mode).

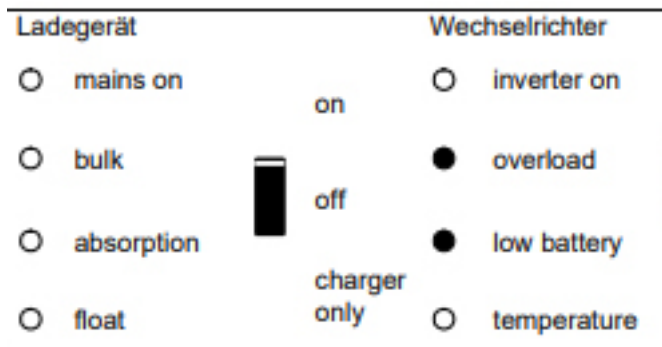

The inverter is switched off as the ripple voltage on the battery connection is too high.

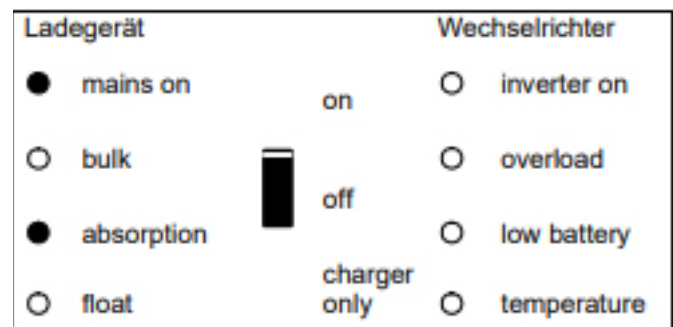

The AC voltage at input AC-in-1 or AC-in-2 is connected through and the charger is in constant voltage mode ("absorption").

Display and operation

Ladegerät		Wechselrichter	
<input checked="" type="radio"/> mains on	on	<input type="radio"/> inverter on	
<input checked="" type="radio"/> bulk	off	<input type="radio"/> overload	
<input checked="" type="radio"/> absorption	charger only	<input type="radio"/> low battery	
<input type="radio"/> float		<input type="radio"/> temperature	

The AC voltage at the input AC-in-1 or AC-in-2 is connected through and the charger is in voltage maintenance or storage mode (“float” or “storage”).

Ladegerät		Wechselrichter	
<input checked="" type="radio"/> mains on	on	<input type="radio"/> inverter on	
<input checked="" type="radio"/> bulk	off	<input type="radio"/> overload	
<input checked="" type="radio"/> absorption	charger only	<input type="radio"/> low battery	
<input type="radio"/> float		<input type="radio"/> temperature	

The AC voltage at the input AC-in-1 or AC-in-2 is connected through and the charger is in “equalisation” mode.

Ladegerät		Wechselrichter	
<input checked="" type="radio"/> mains on	on	<input type="radio"/> inverter on	
<input type="radio"/> bulk	off	<input type="radio"/> overload	
<input checked="" type="radio"/> absorption	charger only	<input type="radio"/> low battery	
<input type="radio"/> float		<input type="radio"/> temperature	

The AC voltage at input AC-in-1 or AC-in-2 is connected through. The input AC current corresponds to the applied load. The charger is regulated down to 0 amperes.

Ladegerät		Wechselrichter	
<input checked="" type="radio"/> mains on	on	<input checked="" type="radio"/> inverter on	
<input type="radio"/> bulk	off	<input type="radio"/> overload	
<input type="radio"/> absorption	charger only	<input type="radio"/> low battery	
<input type="radio"/> float		<input type="radio"/> temperature	

The AC voltage at input AC-in-1 or AC-in-2 is connected through. The load is higher than the external network power. The inverter switches on to supply the missing current.

5.3 Battery module operation

Power switch (A):

- ▶ For switching the battery on or off

SW button (B):

- ▶ Press and hold for approx. 1-2 seconds to start the top master battery. The remaining batteries automatically start in succession.

RUN LED (C):

- ▶ Illuminated LED indicates the battery is in operating mode.

ALM LED (D):

- ▶ Flashing LED indicates a battery error message.
- ▶ An illuminated battery indicates that the protection mechanism has tripped.

Status LEDs (E):

- ▶ 6 status LEDs show the current charging status of the battery.

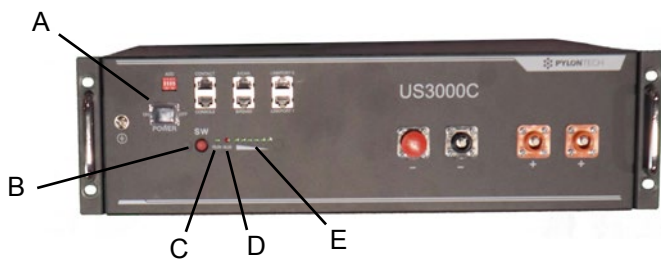

Display and operation

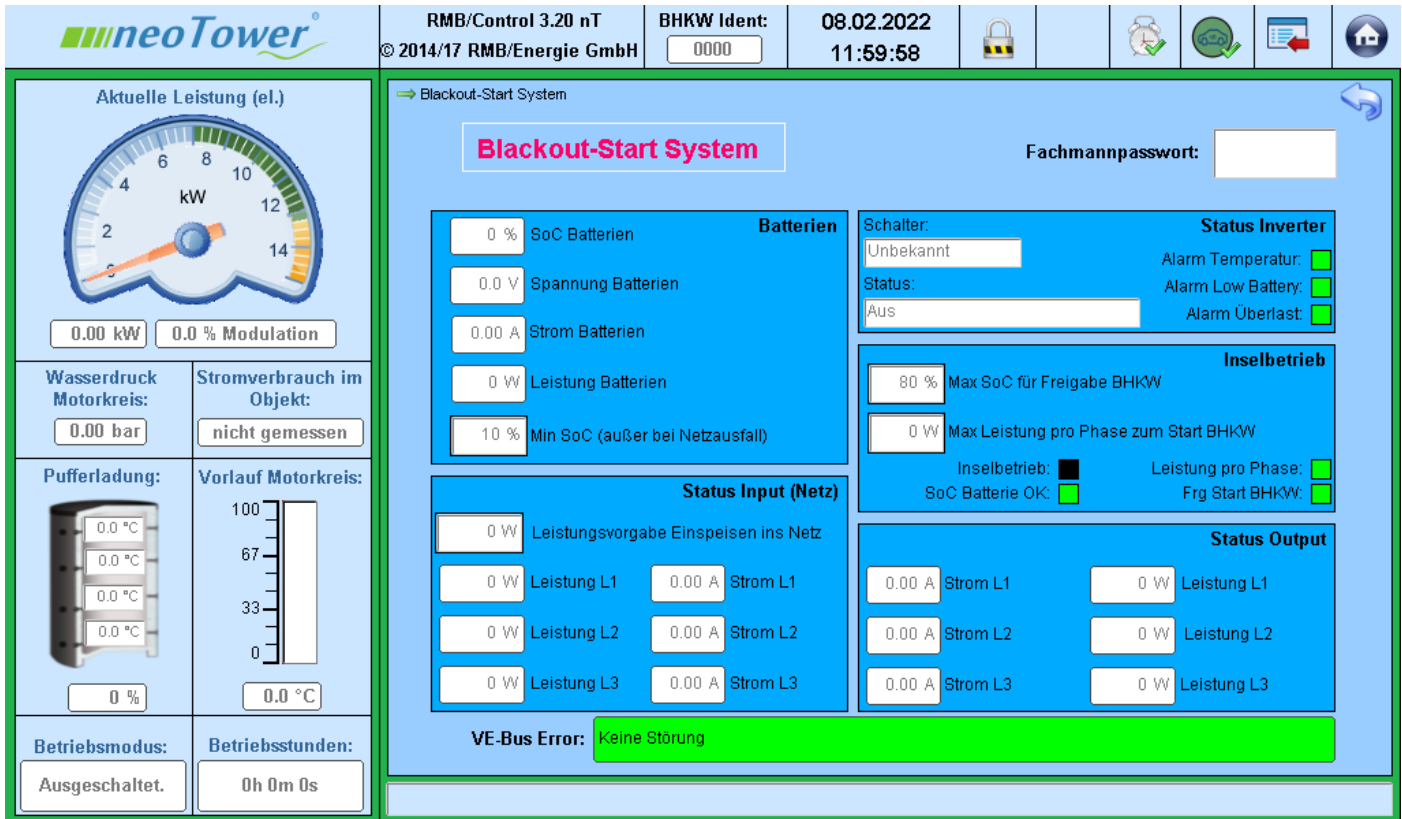

5.4 Explanation of terms

The parameters with the recessed display values can be modified by a technician.

Values with a white background can only be read off.

5.6 Explanation of the terms in the CHP panel

SoC:
State of charge

Battery SoC:
Display of the current state of charge of the batteries in %.

Battery voltage:
Current voltage of the batteries in volts.

Battery current:
Available flowing current of the batteries in amperes.

Battery power:
Current power of the batteries in watts.

Min. SoC (unless there is a power failure):
Minimum permissible state of charge of the

batteries during mains operation in % (set value). In parallel mains operation the value does not fall below this set limit. This ensures a necessary minimum runtime that the BOS system can bridge.

Switch:
Currently set operating mode in plain text.

Status:
Status display of the inverters in plain text.

Temperature alarm:
Display alarm in the event of overtemperature.

Low battery alarm:
Alarm display when the batteries are too low.

Overload alarm:
Alarm display in the event of inverter overload.

Max. SoC for CHP release:
Maximum state of charge of the batteries for enabling start-up of the CHP in standalone mode (set value in %). If the current state of charge of the batteries drops below the set value, the CHP is enabled. If the state of charge is above the set value, the CHP cannot be started.

Max. power per phase to start the CHP:
Maximum permissible power value per phase. This

is necessary for some BOS constellations if the CHP unit is not started by a starter. The starting current would overload the system and the CHP unit would not be able to start (set value in watts).

Standalone operation:

Display whether standalone operation is active (mains failure).

Power per phase:

Release display indicating whether the power per phase to start the CHP is OK.

Battery SoC OK:

Release display indicating whether the power per phase to start the CHP is OK.

CHP start-up enabled:

Display for overall release for CHP start-up in standalone mode (all the above releases must be enabled).

Power specifications, mains network supply:

Specification of how many watts are to be permanently supplied to the mains network or taken from the mains network (set value in watts).

Power L1/L2/L3:

Display of the current power on the mains side in watts.

Current L1/L2/L3:

Display of the present current on the mains side in amperes.

Power L1/L2/L3:

Display of the current power on the building side in watts.

Current L1/L2/L3:

Display of the present current on the building side in amperes.

VE.Bus error:

Currently signalled error message of the BOS system in plain text.

Technician password:

Entry of the technician password to enable modification of the set values.

Maintenance

6. Maintenance

6.1 Functional checks

To ensure trouble-free operation, operational safety, reliability and a long service life of the power storage system, carry out regular functional checks and keep the system clean.

Maintenance of the battery modules installed in the power storage system is not necessary.

Every two weeks:

- ▶ Check the system to ensure that no errors are signalled.

Every six months:

- ▶ Check for any changes to the state of charge.

6.2 Cleaning

ATTENTION!

Damage to the equipment caused by scratched surfaces and/or internal damage due to ingress of water!

- ▶ Do not use abrasive cloths, sponges or cleaning agents.
- ▶ Do not use a water jet.
- ▶ Carefully clean the outside of the storage system with a clean, soft cloth.
- ▶ Check the air filter for soiling. If necessary, replace the filter.

7. Disassembly and disposal

7.1 Disassembly

DANGER!

**Improper disassembly of the power storage system
Risk of death due to electrocution**

- ▶ Only have the storage system dismantled by authorised electricians.

7.2 Disposal

ATTENTION!

**Improper transport of the battery modules
Battery module fire or leakage of hazardous substances!**

- ▶ Only transport the battery modules in packaging that complies with the applicable regulations.
- ▶ Never transport damaged battery modules under any circumstances.
- ▶ NEVER dispose of the power storage system with the components it contains with the household waste!
- ▶ Dispose of the storage system and the batteries it contains in an environmentally compatible manner using the appropriate collection systems.

Technical data

8. Technical data

8.1 Technical data sheet BSS

Version	BSS 7	BSS 11	BSS 21
	General		
Battery storage size (gross) [kWh]	7,1	10,7	21,3
Max. output power [VA]	3000	5000	10000
Max. efficiency [%]	n.a.	n.a.	n.a.
Continuous charging power [VA]	1700	3400	6700
Connections	1x 230 V (AC in) 1x 230 V (AC out) 1x 48 V (DC)		2x 230 V (AC in) 2x 230 V (AC out) 1x 48 V (DC)
Cable cross section (50m max.)	2.5mm ² , 16A	4mm ² , 25A	4mm ² , 25A
PV connection	Mains parallel		
Storage function	Zero reference control via CHP		
Cooling principle	Fan ventilation		
Operating modes	Mains replacement and network-forming standalone operation		
Measurements	Per phase current and power measurement		
Display	LED display on the unit		
Protection class	IP20	IP20	IP20
Operating temperature [°C]	5-30	5-30	5-30
Humidity [%]	max. 95	max. 95	max. 95
Unit consumption [W]	11	18	36
Visualisation	CHP panel	CHP panel	CHP panel
Weight [kg]	222	267	469
Number of cabinets ⁽¹⁾	1	1	2
Dimensions per cabinet (LxWxH) [mm]	600 x 600 x 2.000		
	Inverter		
Manufacturer	Victron		
Power [kW]	3	5	10
	Battery modules		
Manufacturer	Pylontech		
Gross capacity	2x 3552 Wh / 74 Ah	3x 3552 Wh / 74 Ah	6x 3552 Wh / 74 Ah
Operating voltage [V]	48	48	48
Cell type	LiFePo4	LiFePo4	LiFePo4
Efficiency [%]	90-95	90-95	90-95
	Standards and directives		
Safety	VDE-AR-N 4105:2018-11 EN-IEC 60335-1, EN-IEC 60335-2-29 EN-IEC 62109-1, EN-IEC 62109-2		
Emissions	EN 55014-1, EN 55014-2 EN-IEC 61000-3-2, EN-IEC 61000-3-3 IEC 61000-6-1, IEC 61000-6-2, IEC 61000-6-3		

(1) The cabinets must always be positioned side by side.

Deviating values depending on ambient and operating conditions.

Subject to technical modifications, design variations and errors.

8.2 Technical data sheet BOS

Version	BOS 18	BOS 21	BOS 36	BOS 57	BOS 114
General					
Battery storage size (gross) [kWh]	17,8	21,3	35,5	56,8	113,7
Max. output power [VA]	9000	15000	24000	45000	90000
Max. total efficiency [%]	n.a.	n.a.	n.a.	n.a.	n.a.
Continuous charging power [VA]	5000	10000	15800	28800	57600
Connections	3x 230 V (AC in) 3x 230 V (AC out) 1x 48 V (DC)				
Cable cross section (50m max.)	6mm ² , 32A	10mm ² , 50A	16mm ² , 63A	35mm ² , 80A	95mm ² , 160A
Suitable CHP unit power size [kW _{el}] ⁽¹⁾	2.0 - 4.0	2.0 - 4.0, 9.5	2.0 - 4.0, 5.0, 7.2, 9.5, 12.5	2.0 - 30.0	2.0 - 50.0
PV connection	Mains parallel				
Storage function	Zero reference control via CHP				
Cooling principle	Fan ventilation				
Operating modes	Mains replacement, network-forming standalone operation				
Measurements	Per phase current and power measurement				
Display	LED display on the unit				
Protection class	IP20	IP20	IP20	IP20	IP20
Operating temperature [°C]	5-30	5-30	5-30	5-30	5-30
Humidity [%]	max. 95	max. 95	max. 95	max. 95	max. 95
Unit consumption [W]	33	54	150	240	480
Visualisation	CHP panel	CHP panel	CHP panel	CHP panel	CHP panel
Weight [kg]	435	502	667	1216	2371
Number of cabinets ⁽²⁾	2	2	2	3	6
Dimensions per cabinet (LxWxH) [mm]	600 x 600 x 2.000			800 x 800 x 2.000	
Inverter					
Manufacturer	Victron				
Power [kW]	9	15	24	45	90
Battery modules					
Manufacturer	Pylontech				
Gross capacity	5x3552 Wh/74 Ah	6x3552 Wh/74 Ah	10x3552 Wh/74 Ah	16x3552 Wh/74 Ah	32x3552 Wh/74 Ah
Operating voltage [V]	48				
Cell type	LiFePo4				
Efficiency [%]	90 - 95				
Standards and directives					
Safety	VDE-AR-N 4105:2018-11 EN-IEC 60335-1, EN-IEC 60335-2-29 EN-IEC 62109-1, EN-IEC 62109-2				
Emissions	EN 55014-1, EN 55014-2 EN-IEC 61000-3-2, EN-IEC 61000-3-3 IEC 61000-6-1, IEC 61000-6-2, IEC 61000-6-3				

(1) Applies to systems built in 2022 or later. Testing by the manufacturer required.

(2) The cabinets must always be positioned side by side.

Deviating values depending on ambient and operating conditions.

Subject to technical modifications, design variations and errors.



RMB/ENERGIE GmbH
Hauptstrasse 543a
26683 Saterland, Germany

Tel.: +49 4498 92288-0
Fax: +49 4498 92288-66

info@rmbenergie.com
www.rmbenergie.com