



neoTower[®]

Combined heat and power

CHP systems for decentralized energy solutions
from 2,0 to 50,0 kW electrical output



RMB ENERGIE

A **YANMAR** COMPANY

**“THERE ARE NUMEROUS MODERN
HEATERS, BUT NONE OF THEM PRODUCE
ELECTRICITY AND HEAT AS EFFICIENTLY
AND EFFECTIVELY AS A
COGENERATION UNIT.”**

JENS BRAKE, CTO
RMB/ENERGIE GmbH



2008
foundation

45
CHP

2,0 - 50,0
kW_{el}

RMB/ENERGIE GmbH is a leading partner for innovative energy solutions. For over a decade, we have been actively shaping the future of energy generation through the development and production of state-of-the-art combined heat and power plants. Our commitment to quality and sustainability has made us specialists in the 2,0 to 50,0 kW power range, and we pride ourselves on driving pioneering technologies.

Our product range is designed to meet your individual needs. Whether you are a small business, an institution or an industrial company, our CHP units provide a reliable and efficient energy source that can be customised to meet a wide range of needs.

With RMB/ENERGIE, you are not only investing in first-class technology, but also in a sustainable and future-oriented energy solution.

REDUCE ENERGY COSTS - SPARE THE ENVIRONMENT



Central Energy Supply

In conventional power production, up to 70 % of the energy from central power plants is lost due to transfer and heat loss.

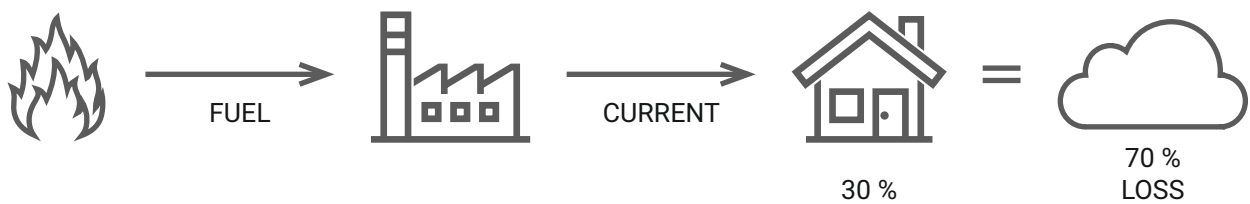

Local Energy Supply

Losses are minimised with cogeneration units such as the neoTower®.

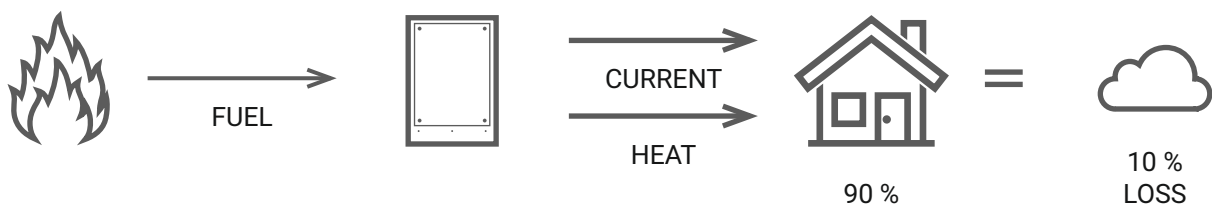



This is how a Cogeneration unit works

A combustion engine powers a high-performance generator which produces electricity. The waste heat of the engine created in the process is used to heat your hot water.

So you produce your energy where it is needed: In your property!

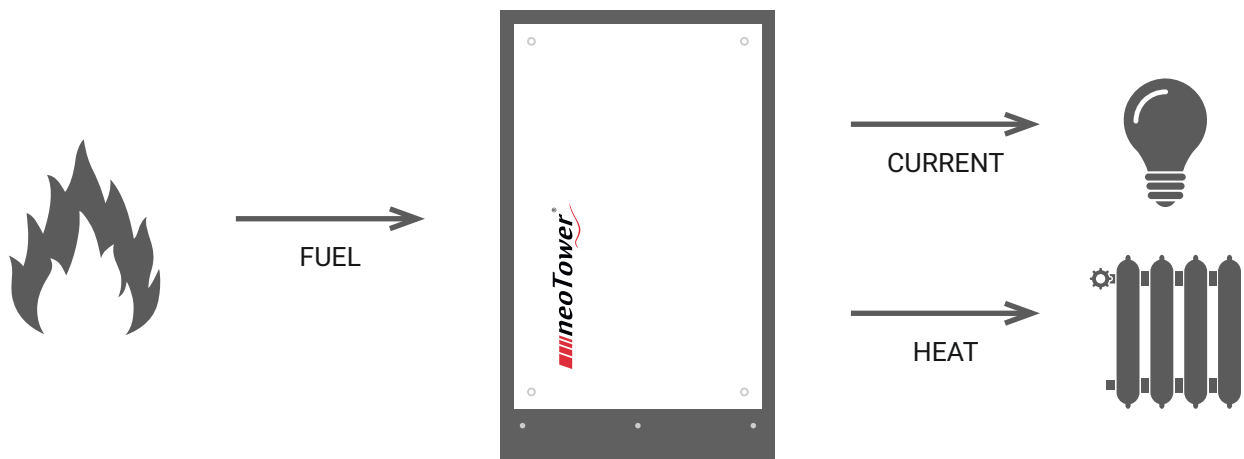

THE COMBINED HEAT AND POWER UNIT



- ✓ Output modulation up to 50 %
- ✓ Standardised condensing technology
- ✓ Natural, liquid and biogas operation
- ✓ Hydrogen admixture suitable up to 40 %
- ✓ Compatibility with cascading
- ✓ Blackout start option
- ✓ 2 year warranty



EFFICIENT

You save money with the simultaneous production of electricity and heat. The more operating hours your neoTower® operates per year, the more money you have in your wallet. Short amortisation times and low maintenance costs are additional indicators of a sound investment.



ENVIRONMENTALLY-FRIENDLY

With the neoTower®, you reduce not only CO₂ emissions but also spare valuable primary energy with highly efficient use. In addition, transfer losses are minimised due to short transport routes, because you only produce the energy where it is needed: in the location of consumption.



INDEPENDENCE

With the neoTower®, you gain independence from rising energy costs. Since heat and valuable electricity are produced at the same time, you gain a measure of independence from the national grid.



The neoTower® is quiet, durable, efficient and compact. Intelligently designed, soundly insulated and the very low engine speed assure low-noise operation and maximise service life. Therefore, neoTower® cogeneration units are also well-suited for properties with higher demands on comfort, such as hotels or nursing homes. A degree of efficiency of up to 109.5 % is a testament to maximum efficiency. With the compact design and optional dismantled delivery, the neoTower® can be used in nearly any location.



Intuitive operation

The neoTower® is easy to operate. You can change settings and have current consumption and production values displayed as required.



Communication interface

With a communication module available as an accessory, the systems can be connected to an on-site building management system (BMS) or other digital devices.



Remote monitoring

Every neoTower® can be connected to the Internet through the mobile router provided, including a SIM card (valid for 24 months), or by Ethernet. This gives you worldwide access to the CHP round the clock. Every unit is monitored by RMB/ENERGIE GmbH in real time, so that remote maintenance can be performed.



Long maintenance intervals

With a constant low speed, the neoTower® minimises the operational wear of the parts. The result is very long maintenance intervals.

POWER MODULATION

The setting of the neoTower® can be either power or heat optimized.
It can adapt its output to the current demand of your property.
In this way, only what is currently needed is produced.



neoTower

FOR EVERY PROPERTY - ALWAYS ECONOMICAL

neoTower® 2.0, 3.3, 4.0, 5.0

Already suitable for private homes

neoTower® 8.0, 9.5, 11.0, 12.5

For an annual heat requirement starting from approx.:

70.000 kWh

neoTower® 17.0, 21.0, 25.0, 30.0

For an annual heat requirement starting from approx.:

150.000 kWh

neoTower® 50.0 (S/HT/CV)

For an annual heat requirement starting from approx.:

300.000 kWh



Hospitals



Factories



Banks



Hotels



Residential areas



Shopping centres



Schools



Private homes



Swimming pools



Workshops



Nursing homes



Agriculture



STANDARDISED CONDENSING TECHNOLOGY

With the standardised integrated condensing technology, the neoTower® cogeneration units achieve energy efficiency levels of up to 109.5 %.



FLEXIBLE SWITCHING OPTION

With the bi-fuel accessory, it can be freely decided at any time which fuel the neoTower® is to run on.



DURABLE INDUSTRIAL COMPONENTS

Three- and four-cylinder industrial engines from YANMAR and MAN. Thanks to their durability, these industrial gas engines are ideally suited for use in cogeneration units.

In combination with highperformance generators from Emod and Marelli, the components are the heart of every neoTower®.

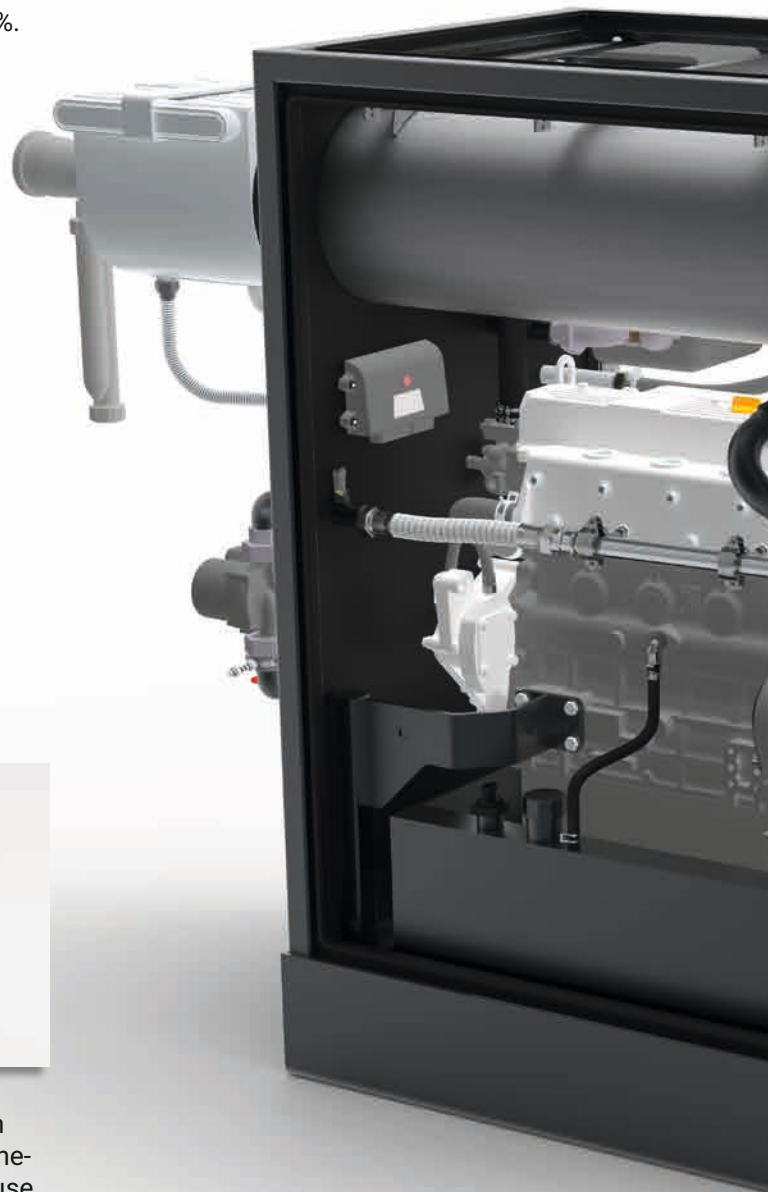



BLACKOUT-START

In the event of a power failure, the neoTower® is operated in grid backup mode for an unlimited period of time. The cogeneration unit is now able to start independently by means of the electricity storage unit and ensure the energy demand.



PRETTY SMART

The RMB/REPORT documents all current and past production values and presents them in a clear arrangement. This allows worldwide access to all relevant data in real-time. At the same time, the parameters can also be customised and the unit can be controlled remotely.



CHARGING-BUTTON

From the neoTower® directly into the car: With the electric vehicle charging button, electromobility is optimized economically and ecologically.

Use the neoTower® as a charging station for e-bikes, e-scooters and any other electric vehicle.

neoTower® 2.0, 3.3, 4.0, 5.0 Natural gas / Biomethane

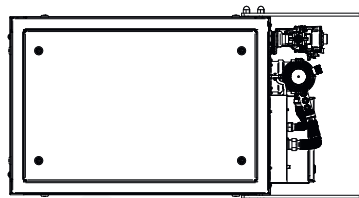
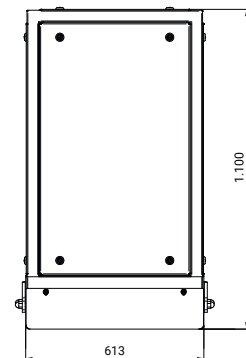
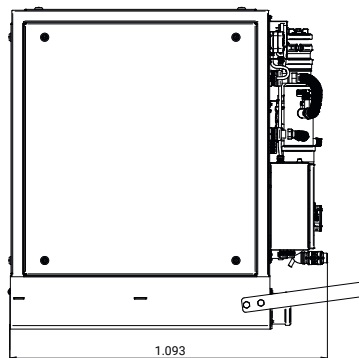
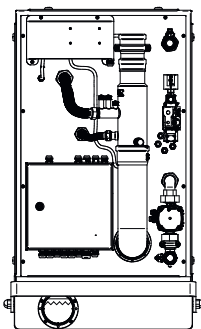



TECHNICAL DATA

neoTower®	2.0	3.3	4.0	5.0
Rated output - electrical [kWel]	2,0	3,3	4,0	5,0
Rated output - thermal [kWth]	5,2	8,2	8,8	12,9
Power modulation - electrical [kWel]	1,1 - 2,0	2,0 - 3,3	2,0 - 4,0	2,5 - 5,0
Power modulation - thermal [kWth]	3,8 - 5,2	5,9 - 8,2	5,9 - 8,8	8,2 - 12,9
f Primary energy factor	0,445	0,378	0,302	0,355
ErP energy efficiency label	A+	A++	A++	A++
Maintenance interval [op. hrs]	15.000	15.000	15.000	15.000
	EFFICIENCY RATIOS			
Electrical efficiency ratio el [%]	27,8	29,5	31,8	29,6
Thermal efficiency ratio th [%]	72,3	73,0	69,8	76,4
Total efficiency ratio total [%]	100,1	102,5	101,6	106,0
	HEAT EXTRACTION			
Flow temperature ± 5 [°C]	75	75	75	75
Return flow temperature ± 5 [°C]	25 - 65	25 - 65	25 - 65	25 - 65
	ELECTRICAL ENERGY GENERATION			
Nominal voltage [V]	400	400	400	400
Frequency [Hz]	50	50	50	50
	MOTOR			
Motor manufacturer	YANMAR	YANMAR	YANMAR	YANMAR
Number of cylinders	3	3	3	3
Displacement [l]	0,7	0,7	0,7	0,7
Air-fuel ratio λ	1,0	1,0	1,0	1,0
	GENERATOR			
Generator type	asynchron	asynchron	asynchron	asynchron
Speed [rpm]	1.020	1.540	1.540	1.540
	DIMENSIONS & WEIGHT			
Dimensions of module L x W x H [mm]	1.093 x 613 x 1.100	1.093 x 613 x 1.100	1.093 x 613 x 1.100	1.093 x 613 x 1.100
Weight approx. [kg]	450	450	450	450



Datasheet
neoTower® 2.0, 3.3, 4.0, 5.0

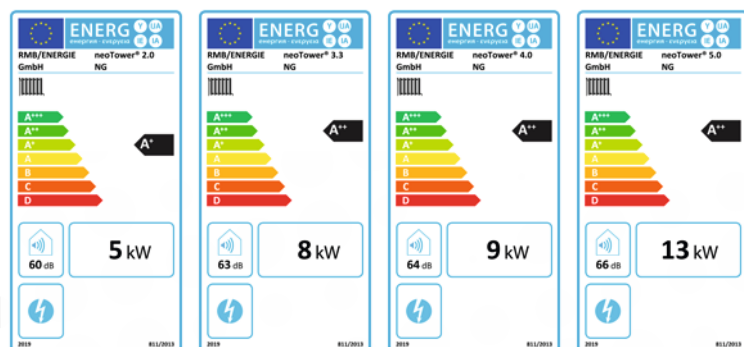

Technical changes, design variations and errors excepted.

neoTower® 2.0, 3.3, 4.0, 5.0 Liquefied gas / BioLPG

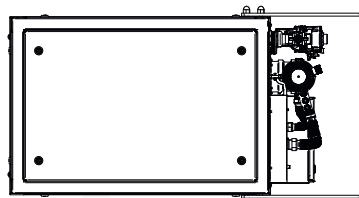
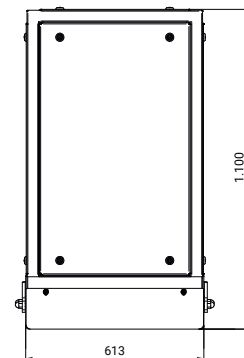
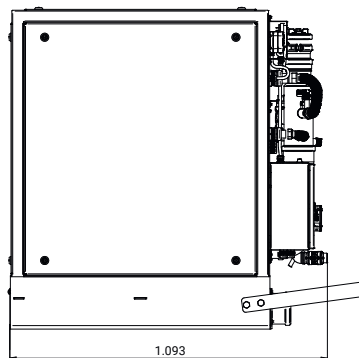
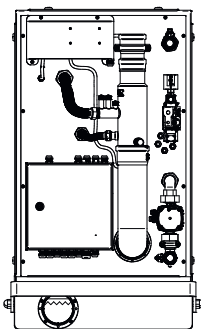



TECHNICAL DATA

neoTower®	2.0	3.3	4.0	5.0
Rated output - electrical [kWel]	2,0	3,3	4,0	5,0
Rated output - thermal [kWth]	6,0	10,1	11,2	13,0
Power modulation - electrical [kWel]	1,1 - 2,0	2,0 - 3,3	2,0 - 4,0	2,5 - 5,0
Power modulation - thermal [kWth]	4,3 - 6,0	7,5 - 10,1	7,5 - 11,2	8,6 - 13,0
f Primary energy factor	0,652	0,524	0,490	0,457
ErP energy efficiency label	A+	A+	A+	A+
Maintenance interval [op. hrs]	15.000	15.000	15.000	15.000
	EFFICIENCY RATIOS			
Electrical efficiency ratio el [%]	23,0	25,0	26,5	27,6
Thermal efficiency ratio th [%]	69,5	76,5	73,8	71,7
Total efficiency ratio total [%]	92,5	101,4	100,2	99,3
	HEAT EXTRACTION			
Flow temperature ± 5 [°C]	75	75	75	75
Return flow temperature ± 5 [°C]	25 - 65	25 - 65	25 - 65	25 - 65
	ELECTRICAL ENERGY GENERATION			
Nominal voltage [V]	400	400	400	400
Frequency [Hz]	50	50	50	50
	MOTOR			
Motor manufacturer	YANMAR	YANMAR	YANMAR	YANMAR
Number of cylinders	3	3	3	3
Displacement [l]	0,7	0,7	0,7	0,7
Air-fuel ratio λ	1,0	1,0	1,0	1,0
	GENERATOR			
Generator type	asynchron	asynchron	asynchron	asynchron
Speed [rpm]	1.020	1.540	1.540	1.540
	DIMENSIONS & WEIGHT			
Dimensions of module L x W x H [mm]	1.093 x 613 x 1.100	1.093 x 613 x 1.100	1.093 x 613 x 1.100	1.093 x 613 x 1.100
Weight approx. [kg]	450	450	450	450



Datasheet
neoTower® 2.0, 3.3, 4.0, 5.0

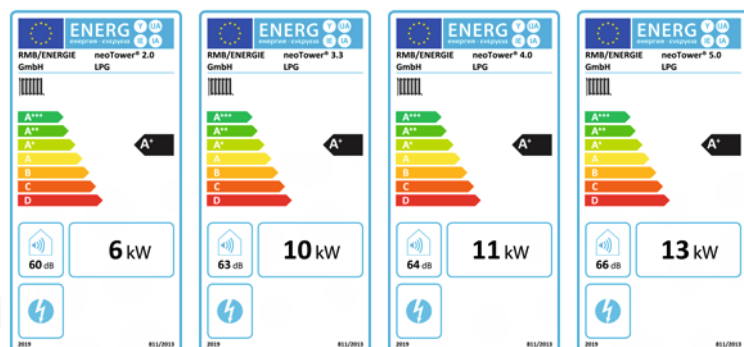

Technical changes, design variations and errors excepted.

neoTower[®] 8.0, 9.5, 11.0, 12.5 Natural gas / Biomethane

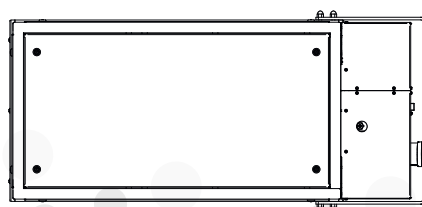
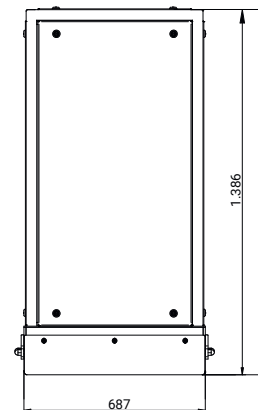
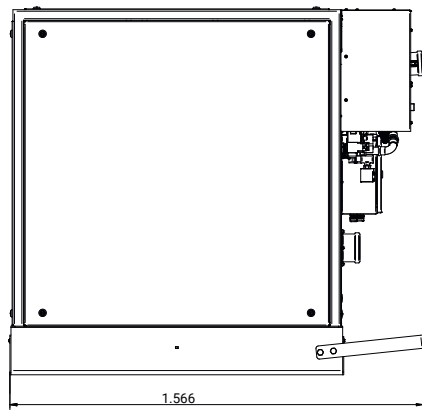
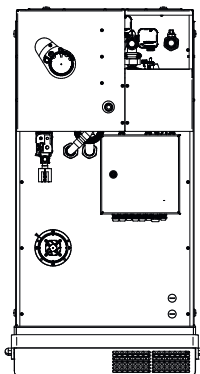



TECHNICAL DATA

neoTower®	8.0	9.5	11.0	12.5
Rated output - electrical [kWel]	8,0	9,5	11,0	12,5
Rated output - thermal [kWth]	20,4	22,7	26,2	27,6
Power modulation - electrical [kWel]	5,5 - 8,0	5,0 - 9,5	5,5 - 11,0	6,0 - 12,5
Power modulation - thermal [kWth]	16,3 - 20,4	12,0 - 22,7	16,5 - 26,2	13,3 - 27,6
f Primary energy factor	0,348	0,282	0,259	0,220
ErP energy efficiency label	A++	A++	A++	A++
Maintenance interval [op. hrs]	13.000	13.000	13.000	13.000
	EFFICIENCY RATIOS			
Electrical efficiency ratio el [%]	29,8	31,7	32,2	33,5
Thermal efficiency ratio th [%]	76,1	75,6	76,7	73,9
Total efficiency ratio total [%]	105,9	107,3	108,9	107,4
	HEAT EXTRACTION			
Flow temperature ± 5 [°C]	80	80	80	80
Return flow temperature ± 5 [°C]	25 - 65	25 - 65	25 - 65	25 - 65
	ELECTRICAL ENERGY GENERATION			
Nominal voltage [V]	400	400	400	400
Frequency [Hz]	50	50	50	50
	MOTOR			
Motor manufacturer	YANMAR	YANMAR	YANMAR	YANMAR
Number of cylinders	3	3	3	3
Displacement [l]	1,7	1,7	1,7	1,7
Air-fuel ratio λ	1,0	1,0	1,0	1,0
	GENERATOR			
Generator type	asynchron	asynchron	asynchron	asynchron
Speed [rpm]	1.540	1.540	1.540	1.540
	DIMENSIONS & WEIGHT			
Dimensions of module L x W x H [mm]	1.566 x 687 x 1.386	1.566 x 687 x 1.386	1.566 x 687 x 1.386	1.566 x 687 x 1.386
Weight approx. [kg]	818	818	818	818



Datasheet
neoTower® 8.0, 9.5, 11.0, 12.5

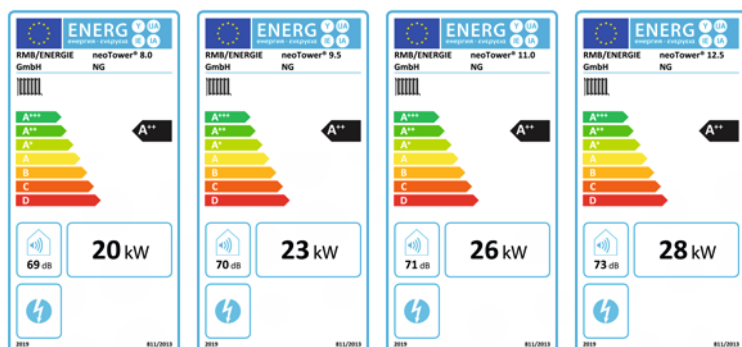

Technical changes, design variations and errors excepted.

neoTower[®] 8.0, 9.5, 11.0, 12.5 Liquefied gas / BioLPG

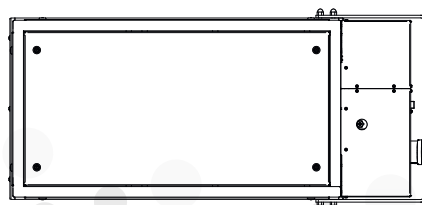
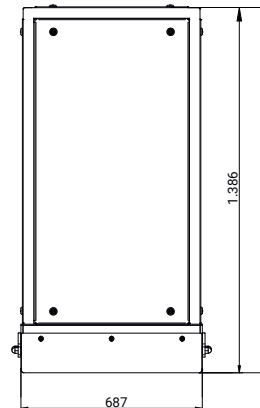
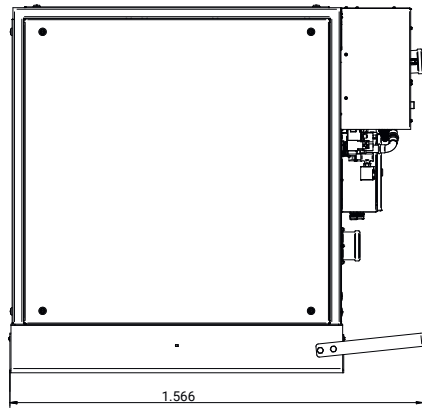
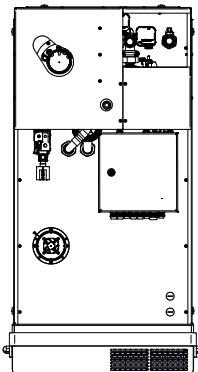



TECHNICAL DATA

neoTower®	8.0	9.5	11.0	12.5
Rated output - electrical [kWel]	8,0	9,5	11,0	12,5
Rated output - thermal [kWth]	21,0	23,1	26,0	28,6
Power modulation - electrical [kWel]	5,5 - 8,0	5,0 - 9,5	5,5 - 11,0	6,0 - 12,5
Power modulation - thermal [kWth]	17,5 - 21,0	16,1 - 23,1	17,4 - 26,0	18,1 - 28,6
f Primary energy factor	0,496	0,410	0,398	0,373
ErP energy efficiency label	A+	A++	A++	A++
Maintenance interval [op. hrs]	13.000	13.000	13.000	13.000
	EFFICIENCY RATIOS			
Electrical efficiency ratio el [%]	26,8	29,0	29,4	30,1
Thermal efficiency ratio th [%]	70,4	70,4	69,5	68,9
Total efficiency ratio total [%]	97,2	99,4	98,9	99,0
	HEAT EXTRACTION			
Flow temperature ± 5 [°C]	80	80	80	80
Return flow temperature ± 5 [°C]	25 - 65	25 - 65	25 - 65	25 - 65
	ELECTRICAL ENERGY GENERATION			
Nominal voltage [V]	400	400	400	400
Frequency [Hz]	50	50	50	50
	MOTOR			
Motor manufacturer	YANMAR	YANMAR	YANMAR	YANMAR
Number of cylinders	3	3	3	3
Displacement [l]	1,7	1,7	1,7	1,7
Air-fuel ratio λ	1,0	1,0	1,0	1,0
	GENERATOR			
Generator type	asynchron	asynchron	asynchron	asynchron
Speed [rpm]	1.540	1.540	1.540	1.540
	DIMENSIONS & WEIGHT			
Dimensions of module L x W x H [mm]	1.566 x 687 x 1.386	1.566 x 687 x 1.386	1.566 x 687 x 1.386	1.566 x 687 x 1.386
Weight approx. [kg]	818	818	818	818



Datasheet
neoTower® 8.0, 9.5, 11.0, 12.5

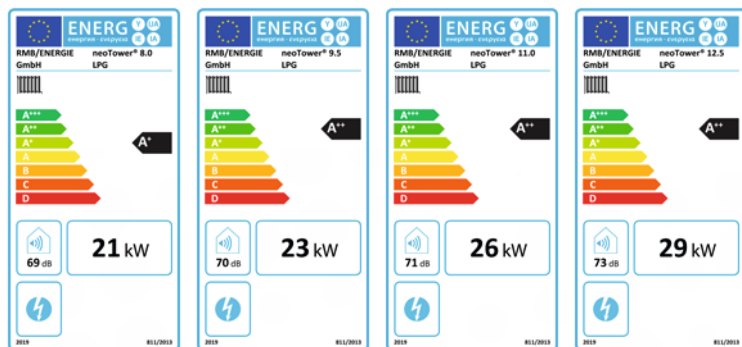

Technical changes, design variations and errors excepted.

neoTower® 17.0, 21.0, 25.0, 30.0 Natural gas / Biomethane

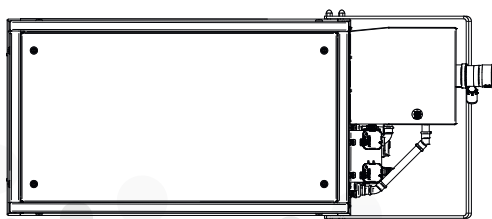
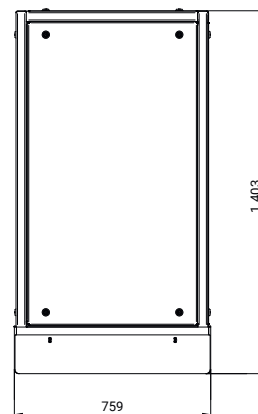
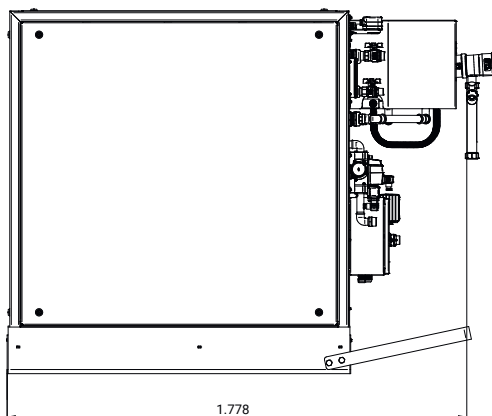
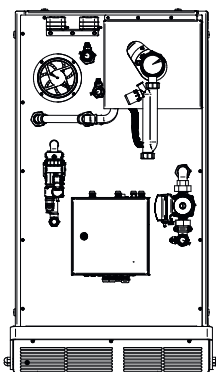



TECHNICAL DATA

neoTower®	17.0	21.0	25.0	30.0
Rated output - electrical [kWel]	17,0	21,0	25,0	30,0
Rated output - thermal [kWth]	41,6	47,6	54,9	63,1
Power modulation - electrical [kWel]	10,0 - 17,0	10,0 - 21,0	12,5 - 25,0	15,0 - 30,0
Power modulation - thermal [kWth]	31,8 - 41,6	32,0 - 47,6	34,8 - 54,9	40,9 - 63,1
f Primary energy factor	0,349	0,314	0,266	0,229
ErP energy efficiency label	A++	A++	A++	A++
Maintenance interval [op. hrs]	10.000	8.000	8.000	8.000
EFFICIENCY RATIOS				
Electrical efficiency ratio el [%]	30,1	31,3	32,5	33,5
Thermal efficiency ratio th [%]	73,7	71,0	71,4	70,5
Total efficiency ratio total [%]	103,8	102,3	103,9	104,0
HEAT EXTRACTION				
Flow temperature ± 5 [°C]	80	80	80	80
Return flow temperature ± 5 [°C]	25 - 65	25 - 65	25 - 65	25 - 65
ELECTRICAL ENERGY GENERATION				
Nominal voltage [V]	400	400	400	400
Frequency [Hz]	50	50	50	50
MOTOR				
Motor manufacturer	YANMAR	YANMAR	YANMAR	YANMAR
Number of cylinders	4	4	4	4
Displacement [l]	3,3	3,3	3,3	3,3
Air-fuel ratio λ	1,0	1,0	1,0	1,0
GENERATOR				
Generator type	asynchron	asynchron	asynchron	asynchron
Speed [rpm]	1.530	1.530	1.530	1.530
DIMENSIONS & WEIGHT				
Dimensions of module L x W x H [mm]	1.778 x 759 x 1.403	1.778 x 759 x 1.403	1.778 x 759 x 1.403	1.778 x 759 x 1.403
Weight approx. [kg]	1.038	1.038	1.038	1.038



Datasheet
neoTower® 17.0, 21.0, 25.0, 30.0

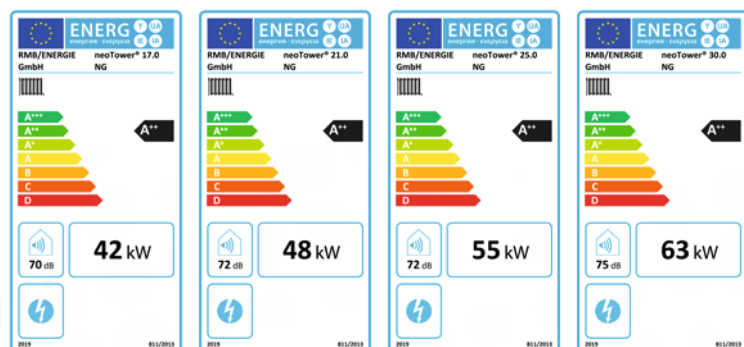

Technical changes, design variations and errors excepted.

neoTower® 17.0, 21.0, 25.0, 30.0 Liquefied gas / BioLPG

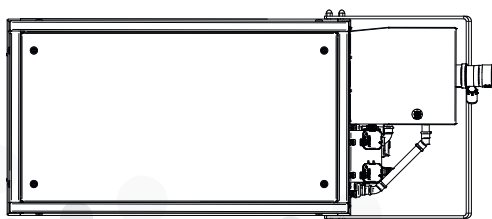
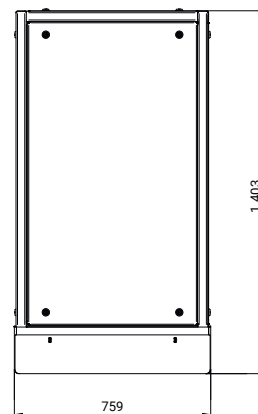
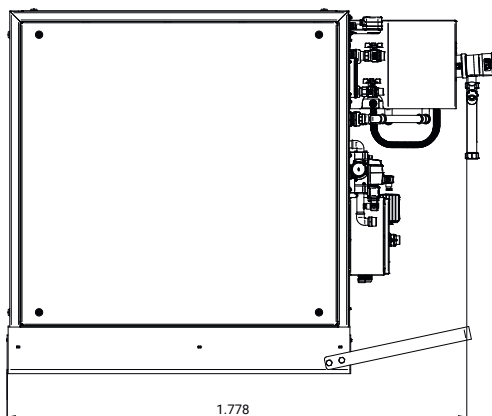
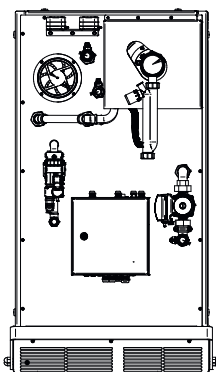



TECHNICAL DATA

neoTower®	17.0	21.0	25.0	30.0
Rated output - electrical [kWel]	17,0	21,0	25,0	30,0
Rated output - thermal [kWth]	40,4	46,6	51,8	57,8
Power modulation - electrical [kWel]	10,0 - 17,0	10,0 - 21,0	12,5 - 25,0	15,0 - 30,0
Power modulation - thermal [kWth]	30,6 - 40,4	30,6 - 46,6	33,4 - 51,8	37,3 - 57,8
f Primary energy factor	0,462	0,407	0,353	0,366
ErP energy efficiency label	A++	A++	A++	A++
Maintenance interval [op. hrs]	10.000	8.000	8.000	8.000
	EFFICIENCY RATIOS			
Electrical efficiency ratio el [%]	28,2	29,7	31,1	31,4
Thermal efficiency ratio th [%]	67,1	65,9	64,6	60,5
Total efficiency ratio total [%]	95,3	95,6	95,7	91,8
	HEAT EXTRACTION			
Flow temperature ± 5 [°C]	80	80	80	80
Return flow temperature ± 5 [°C]	25 - 65	25 - 65	25 - 65	25 - 65
	ELECTRICAL ENERGY GENERATION			
Nominal voltage [V]	400	400	400	400
Frequency [Hz]	50	50	50	50
	MOTOR			
Motor manufacturer	YANMAR	YANMAR	YANMAR	YANMAR
Number of cylinders	4	4	4	4
Displacement [l]	3,3	3,3	3,3	3,3
Air-fuel ratio λ	1,0	1,0	1,0	1,0
	GENERATOR			
Generator type	asynchron	asynchron	asynchron	asynchron
Speed [rpm]	1.530	1.530	1.530	1.530
	DIMENSIONS & WEIGHT			
Dimensions of module L x W x H [mm]	1.778 x 759 x 1.403	1.778 x 759 x 1.403	1.778 x 759 x 1.403	1.778 x 759 x 1.403
Weight approx. [kg]	1.038	1.038	1.038	1.038



Datasheet
neoTower® 17.0, 21.0, 25.0, 30.0

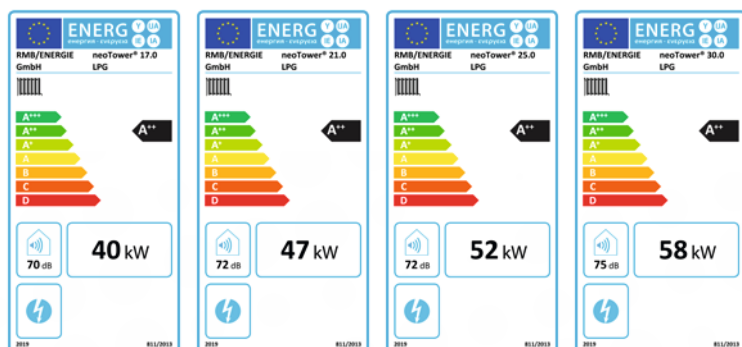

Technical changes, design variations and errors excepted.

neoTower® 50.0 Natural gas / Biomethane

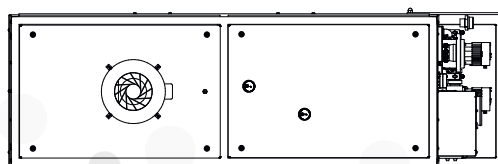
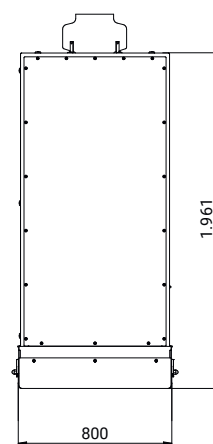
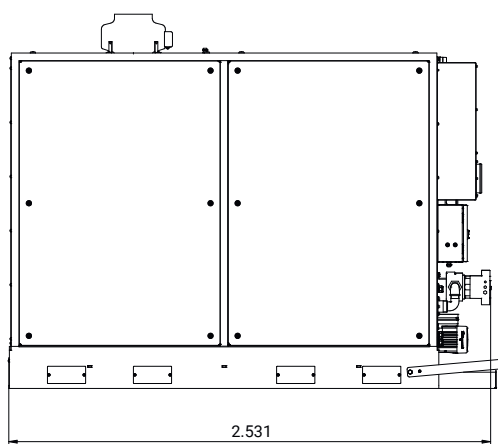
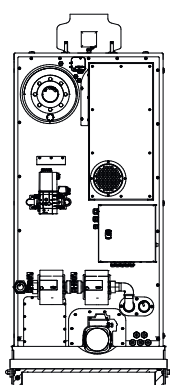



TECHNICAL DATA

neoTower®	50.0 Standard	50.0 High Temperature	50.0 Caloric Value
Rated output - electrical [kWel]	50,0	50,0	50,0
Rated output - thermal [kWth]	85,0	80,0	100,0
Power modulation - electrical [kWel]	25,0 - 50,0	25,0 - 50,0	25,0 - 50,0
Power modulation - thermal [kWth]	52,6 - 85,0	49,5 - 80,0	60,2 - 100,0
f Primary energy factor	0,203	0,216	0,172
ErP energy efficiency label	n.aa		
Maintenance interval [op. hrs]	3.000	3.000	3.000
EFFICIENCY RATIOS			
Electrical efficiency ratio el [%]	35,0	35,0	35,0
Thermal efficiency ratio th [%]	59,4	55,9	69,9
Total efficiency ratio total [%]	94,4	90,9	104,9
HEAT EXTRACTION			
Flow temperature ± 5 [°C]	80	93	80
Return flow temperature ± 5 [°C]	25 - 65	35 - 83	25 - 65
ELECTRICAL ENERGY GENERATION			
Nominal voltage [V]	400	400	400
Frequency [Hz]	50	50	50
MOTOR			
Motor manufacturer	MAN	MAN	MAN
Number of cylinders	4	4	4
Displacement [l]	4,6	4,6	4,6
Air-fuel ratio λ	1,0	1,0	1,0
GENERATOR			
Generator type	synchron	synchron	synchron
Speed [rpm]	1.500	1.500	1.500
DIMENSIONS & WEIGHT			
Dimensions of module L x W x H [mm]	2.531 x 800 x 1.961	2.531 x 800 x 1.961	2.531 x 800 x 1.961
Weight approx. [kg]	2.250	2.250	2.250



Datasheet
neoTower® 50.0

Technical changes, design variations and errors excepted.

neoTower® 50.0 Liquefied gas / BioLPG

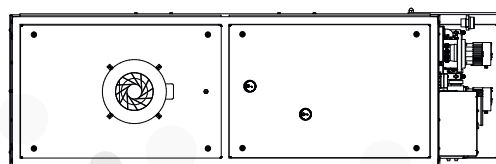
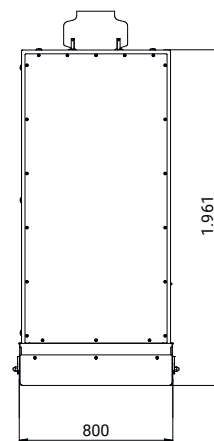
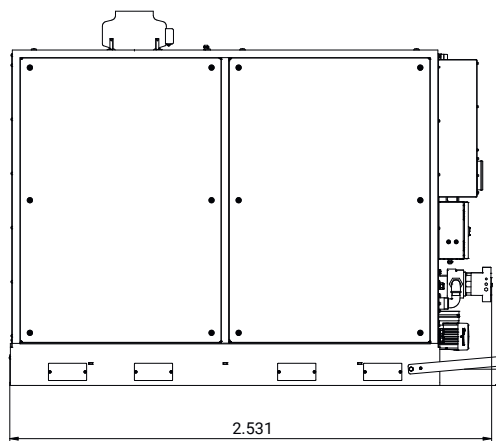
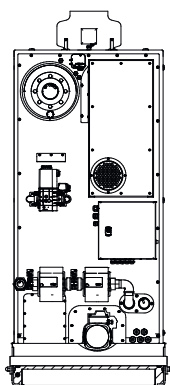



TECHNICAL DATA

neoTower®	50.0 Standard	50.0 High Temperature	50.0 Caloric Value
Rated output - electrical [kWel]	50,0	50,0	50,0
Rated output - thermal [kWth]	87,0	77,3	95,3
Power modulation - electrical [kWel]	25,0 - 50,0	25,0 - 50,0	25,0 - 50,0
Power modulation - thermal [kWth]	55,1 - 87,0	52,7 - 77,3	61,4 - 95,3
f Primary energy factor	0,276	0,349	0,304
ErP energy efficiency label	n. a.		
Maintenance interval [op. hrs]	3.000	3.000	3.000
EFFICIENCY RATIOS			
Electrical efficiency ratio el [%]	33,5	32,9	32,6
Thermal efficiency ratio th [%]	58,4	50,9	62,0
Total efficiency ratio total [%]	91,9	83,9	94,6
HEAT EXTRACTION			
Flow temperature ± 5 [°C]	80	93	80
Return flow temperature ± 5 [°C]	25 - 65	35 - 83	25 - 65
ELECTRICAL ENERGY GENERATION			
Nominal voltage [V]	400	400	400
Frequency [Hz]	50	50	50
MOTOR			
Motor manufacturer	MAN	MAN	MAN
Number of cylinders	4	4	4
Displacement [l]	4,6	4,6	4,6
Air-fuel ratio λ	1,0	1,0	1,0
GENERATOR			
Generator type	synchron	synchron	synchron
Speed [rpm]	1.500	1.500	1.500
DIMENSIONS & WEIGHT			
Dimensions of module L x W x H [mm]	2.531 x 800 x 1.961	2.531 x 800 x 1.961	2.531 x 800 x 1.961
Weight approx. [kg]	2.250	2.250	2.250



Datasheet
neoTower® 50.0

Technical changes, design variations and errors excepted.



TWO COMBINED HEAT AND POWER UNITS REDUCE ELECTRICITY COSTS AND INCREASE THE DEGREE OF SELF-SUFFICIENCY

CHALLENGE

Like most manufacturing companies, Oxytabs in Rendsburg is concerned about the availability of electricity and heat, both in terms of cost and security of supply. For this reason, the company has opted for highly efficient CHP technology from RMB/ENERGIE in a newly built warehouse, thus ensuring a higher degree of self-sufficiency.

As a private label, Oxytabs is a market leader in the manufacture and customisation of cleaning and descaling products - including for fully automatic coffee machines in powder, tablet or liquid form - on behalf of and under the label of other well-known brands. We also provide products for agricultural businesses. Chances are that your current coffee comes from a machine maintained with an Oxytabs product.

SOLUTION

For the new hall, two neoTower® 25.0 combined heat and power units were chosen as a particularly powerful variant in terms of both electricity and heat, as the two units can deliver between 12.5 kW (individually) and 50 kW (combined) of electricity and between 34.8 kW and 109.8 kW of heat in a continuously modulating manner. Krauss Haustechnik GmbH from Klein Offenseth-Sparrieshoop was responsible for the installation. neoTower® combined heat and power units are characterised by the particular robustness of their Yanmar gas engines, which can be run on either natural gas or bio-methane and are already approved for hydrogen blends rates of up to 40 per cent. One reason for their durability is their impressive 3.3 litre displacement. Combined with a low engine speed of just 1,530 rpm and a 90-litre engine oil capacity, this ensures exceptionally long maintenance cycles of 8,000 hours. Permanent remote maintenance, remote monitoring, remote evaluation and remote reporting also ensure long-term worry-free operation.



CONCLUSION

The ever-expanding company Oxytabs, a manufacturer of descaling and cleaning products for households and agriculture based near Rendsburg, relied on the dual power of two neoTower® combined heat and power units, each with an electrical output of 25 kW, for the basic supply of heat and electricity in its new hall. A central heat and power supply is important for the operator in order to secure its own energy supply.

OVERVIEW

Customer:	Oxytabs GmbH
Application:	Factories
Place:	Rendsburg
Cogenerations unit:	2x neoTower® 25.0
Gas type:	Natural gas
Rated output - electrical:	25,0 kW
Rated output - thermal:	54,9 kW



ENERGY TECHNOLOGY IN THE CLIMBING HALL RESTS ON SEVERAL SHOULDERS

CHALLENGE

In buildings used for sporting activities, high overall energy requirements and, in particular, sensitive temperature and ventilation conditions place complex demands on building services engineering. In the climbing and bouldering hall „Die Kletterei“ in Kaufering, Bavaria, which was built in 2016/17, a combined heat and power plant fulfils a significant part of these requirements.

Due to the weather, it is not always possible to practice climbing safely in the nearby alpine mountains. For this reason, Kletter- und Boulderparadies am Lech GmbH built a climbing and bouldering centre in Kaufering in 2016/17 to meet the region's need for a safe training environment all year round. Other parts of the complex include an apartment, offices and a restaurant. Saving energy and resources was an important requirement in the planning, going beyond the legal and building regulations.

SOLUTION

The building services were installed in three phases:

1. installation of the basic equipment with gas condensing boiler and hot water.
2. creation of the conditions (piping and peripherals) for cooling the building.
3. installation of cooling and combined heat and power unit.

From 2019, the CHP will provide the base load and the condensing boiler will provide the peak load. The heat supplied by the CHP unit (and possibly the gas condensing boiler) is not only used for heating in winter. In summer, it is used to feed a 25 kW Fahrenheit adsorption chiller from a storage tank that is continuously heated to 80°C. As the neoTower® operates in modulating mode over a wide output range (from 10.7 kW el. and 29.1 kW therm.), intermittent operation with frequent starts is largely avoided. The unit runs continuously for long periods. This is important not least for the high level of self-sufficiency, which is extremely lucrative for the operator and ensures a manageable payback period.



CONCLUSION

The Kaufering bouldering and climbing centre's basic electricity and heat requirements are met by a clever combination: A neoTower® CHP unit, a gas condensing peak-load boiler and a photovoltaic system contribute to the highly efficient generation of electricity and heat and, with the help of an adsorption chiller, also to cooling in summer.

The investor and operator of the „Die Kletterei“ hall, Markus Wasserle, is very satisfied with the overall concept of the system and praises the „far-sighted planning by the Rössle engineering office“ and in particular the cooperation and service of the CHP manufacturer RMB/ENERGIE: „The cooperation with RMB was excellent! I can only recommend concluding a direct maintenance contract“.

OVERVIEW

Customer:	Die Kletterei
Application:	Sports centre
Place:	Kaufering
Cogenerations unit:	neoTower® 20.0
Gas type:	Natural gas
Rated output - electrical:	20,0 kW
Rated output - thermal:	45,8 kW

CERTIFICATES AND PARTNERSHIPS

We place the highest value on quality, sustainability and compliance with international standards. Our neoTower® combined heat and power units are recognised and certified in various regions, and we are a proud member of renowned associations that are committed to promoting innovative energy systems.



Reliable quality management in accordance with DIN EN ISO 9001 ensures consistently high product and service quality.



DVGW test mark and DVGW quality marks stand for optimal PROTECTION in the gas and water compartment.



The reliable, clean and flexible generation of electricity and heat from CHP systems is called "blue energy" designated.



Our products are SVGW-certified and meet the safety requirements in Switzerland.



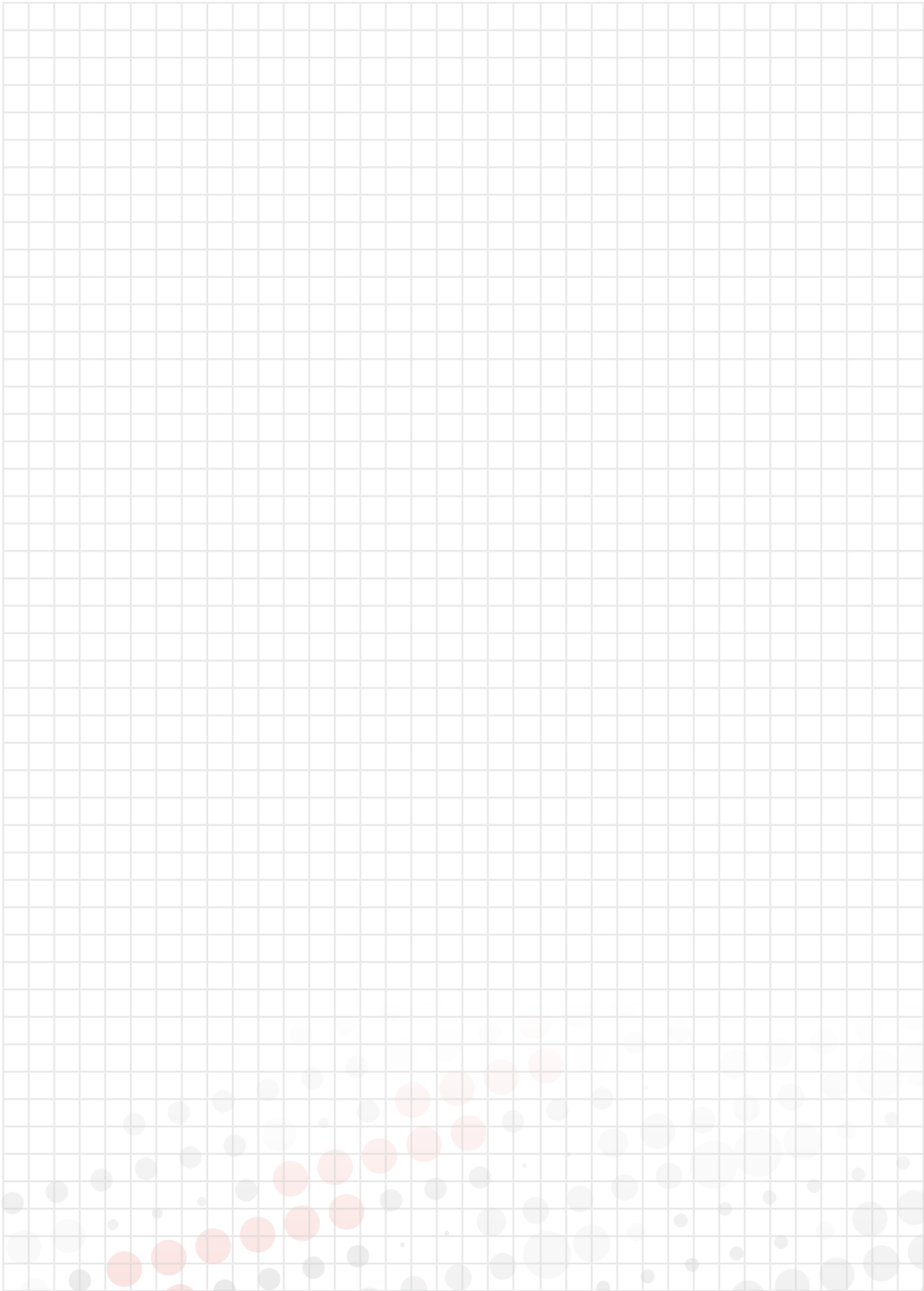

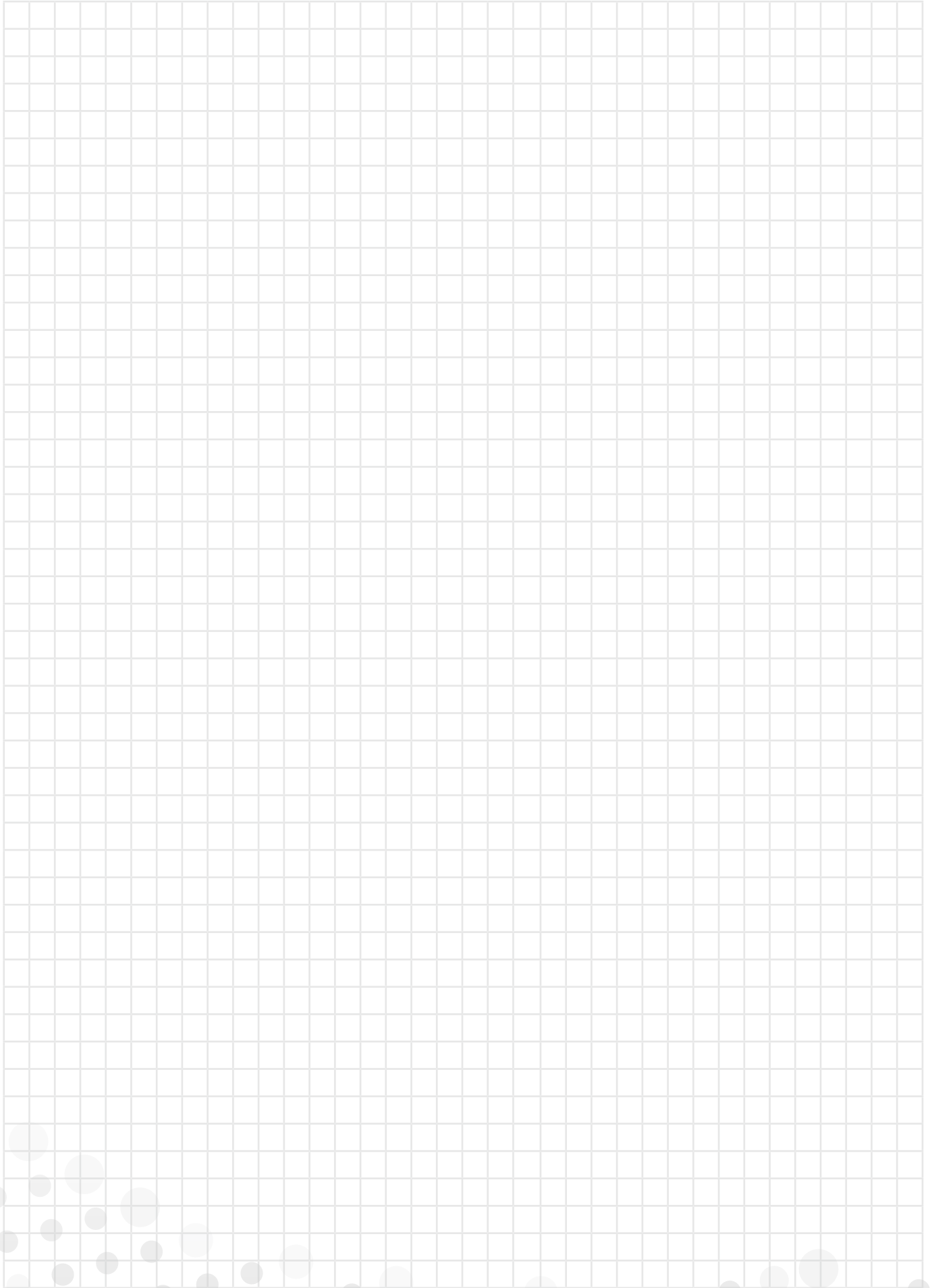

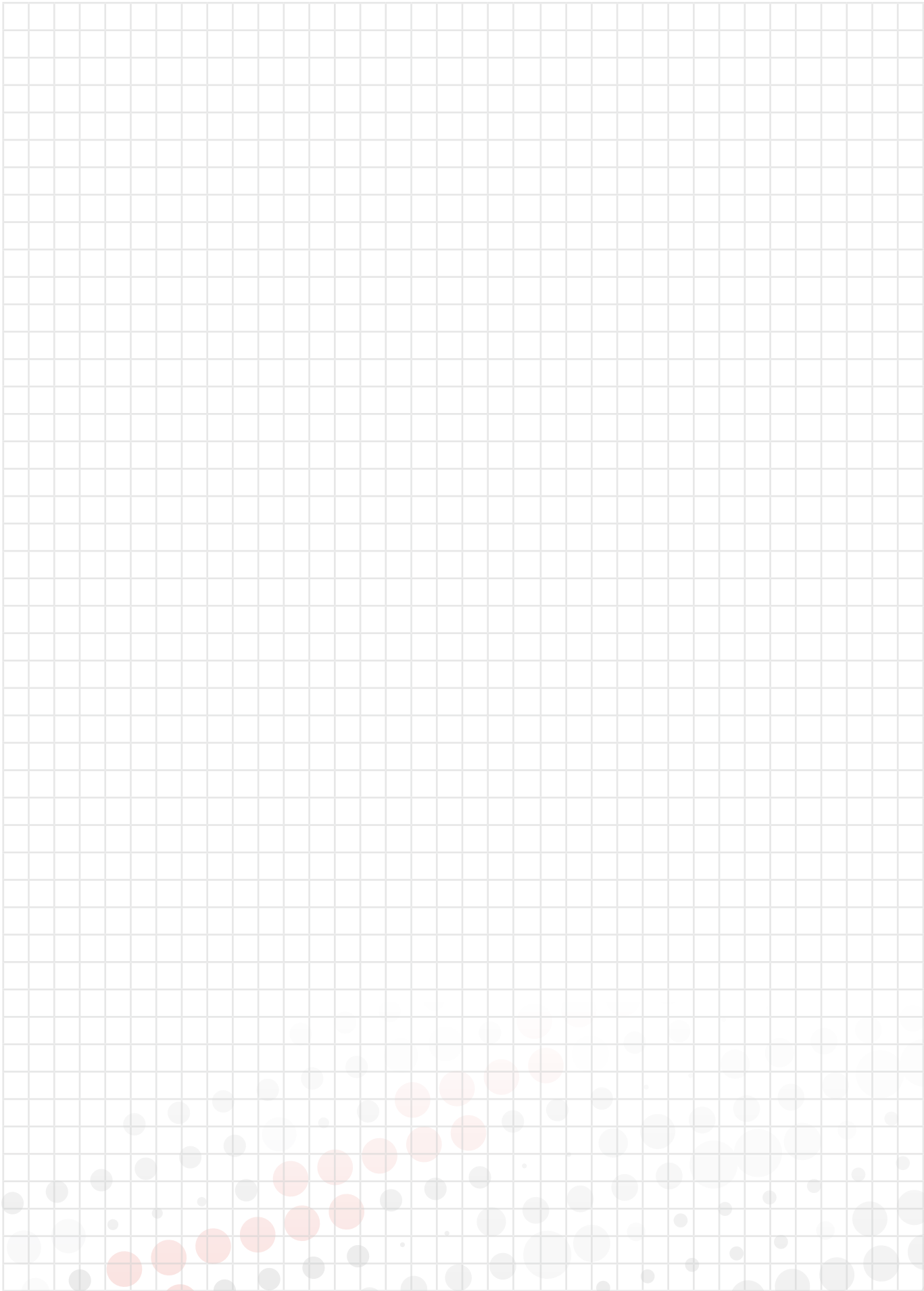

YOUR CHP PARTNER



RMB/ENERGIE GmbH
Hauptstraße 543a
26683 Saterland
GERMANY

Tel.: +49 4498 92288-0
Fax: +49 4498 92288-66

info@rmbenergie.com
www.rmbenergie.com